



# MULTI-UNIT SETUP DIAGRAM

CONNECTING MULTIPLE PATCH MODELS FOR EXPANDED I/O

**HOW-TO:** CONNECT MULTIPLE PATCH SYSTEM MODELS FOR EXPANDED I/O





# MULTI-UNIT SETUP DIAGRAM

CONNECTING MULTIPLE PATCH MODELS FOR EXPANDED I/O

[2] PATCH UNIT EXAMPLE

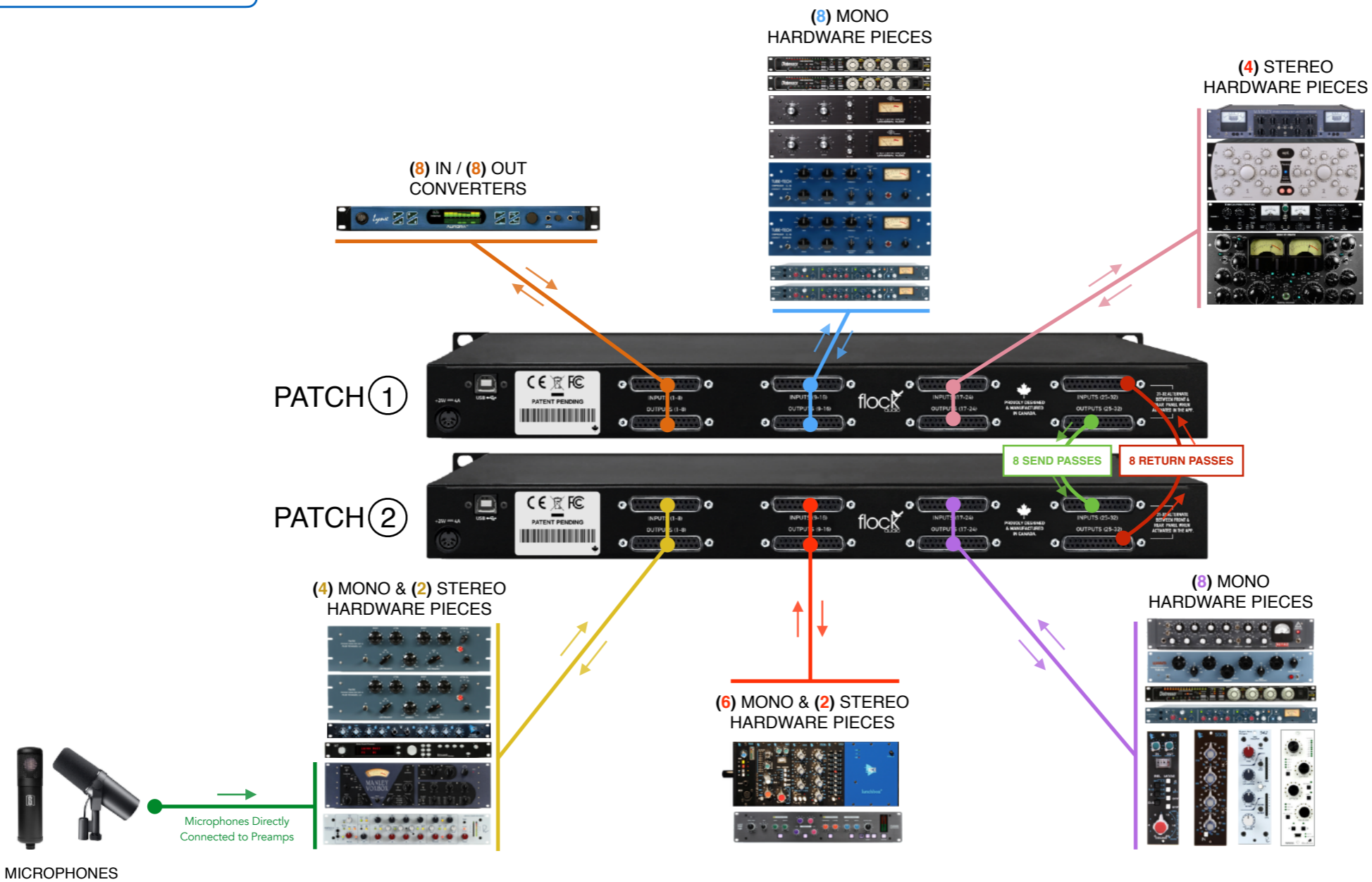

MICROPHONES

Microphones Directly Connected to Preamps

The PATCH Series models are all a +4 Professional Line Level Design. When connecting Microphones directly to the PATCH Series Hardware, Standard Audio Engineering Practices should be exercised such as the understanding that mixing Signal Levels may or may not exhibit audio level &/or electronic noise floor artifacts. If undesired results are experienced when connecting Microphones directly to the PATCH Series, it is recommend to have a dB Booster or Transparent Preamp between the Microphone and PATCH Model Connection (I.E. Mic -> Pre/dB Booster -> PATCH) to achieve the best possible audio signal levels for routing.



# MULTI-UNIT SETUP DIAGRAM

## CONNECTING MULTIPLE PATCH MODELS FOR EXPANDED I/O

### [3] PATCH UNIT EXAMPLE

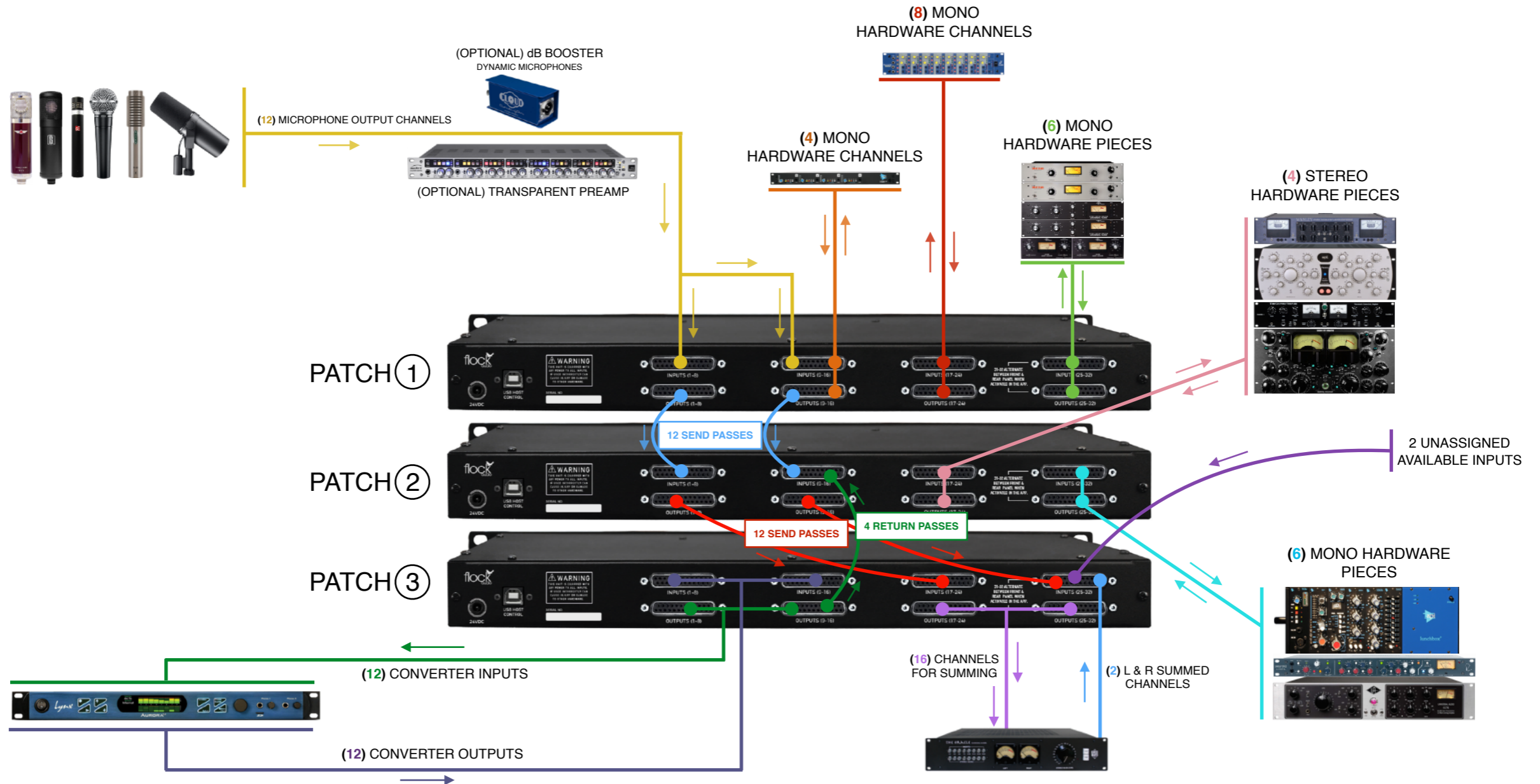

The PATCH Series models are all a +4 Professional Line Level Design. When connecting Microphones directly to the PATCH Series Hardware, Standard Audio Engineering Practices should be exercised such as the understanding that mixing Signal Levels may or may not exhibit audio level &/or electronic noise floor artifacts. If undesired results are experienced when connecting Microphones directly to the PATCH Series, it is recommend to have a dB Booster or Transparent Preamp between the Microphone and PATCH Model Connection (I.E. Mic -> Pre/dB Booster -> PATCH) to achieve the best possible audio signal levels for routing.





# MULTI-UNIT SETUP DIAGRAM

CONNECTING MULTIPLE PATCH MODELS FOR EXPANDED I/O

## MULTIPLE UNIT IDENTIFICATIONS

When using a multiple PATCH unit setup(s), users must designate specific connection configurations between PATCH units in order to send analog signals from one system to the next. PATCH Systems Models are identified in the PATCH APP according to their registered serial numbers. Rearranging the systems to a specific desired order is as simple as clicking + dragging on the serial numbers into a preferred order.

## INPUT/OUTPUT PASSES

Input & Output Passes represent physical connections between PATCH Systems in the application. In order to Send or Receive audio signals between PATCH Units, a specific Send &/or Receive must be chosen with-in the Input/Output Passes section of the Multiple Unit Setup Menu.

This menu has options for recommended suggestions such as Inputs & Outputs (1-8), (9-16), (17-24), (25-32) which will generate 8-16 available sends & receives between PATCH units, or a user can choose "Custom I/O" which will allow the user to designate their own Sends &/or Receives

## FRONT I/O TOGGLE CONTROLS

When multiple PATCH units are connected, users can choose whether the Front Inputs & Outputs are engaged only on the first designated unit or on all connected PATCH Systems. This option allows users to avoid Multiple Unit Setup issues when 31-32 are configured as Sends & Receives between PATCH units and is accessible in the "Settings > User Preferences Menu"

## MULTIPLE PATCH UNIT SETUP MENU (PT.1)



# MULTI-UNIT SETUP DIAGRAM

CONNECTING MULTIPLE PATCH MODELS FOR EXPANDED I/O

## MULTIPLE PATCH UNIT SETUP MENU (PT.2)

### SAVE SETUP

Once a desired Multiple Unit Setup configuration is established, a user must save their setup in order to properly operate their multiple system setup from the PATCH APP.

### UNIT COLOR ASSIGNMENT

When using Multiple PATCH System units, Each PATCH System Hardware Unit is identified by a coloured outline around all available Digital Rack Spaces in the Hardware Index.

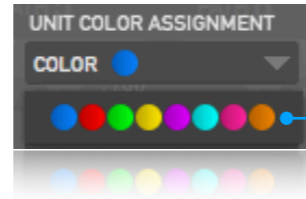

By default the specified colors are indicated from left to right. However, a user can change the color assignment of each PATCH Unit based upon the users preferences by selecting the Unit Color Assignment drop down in the Multiple Setup Menu.

### PATCH MODEL

You can choose your preferred PATCH Model using the Model Dropdown Menu when setting up Multiple Units for expanded I/O configurations.

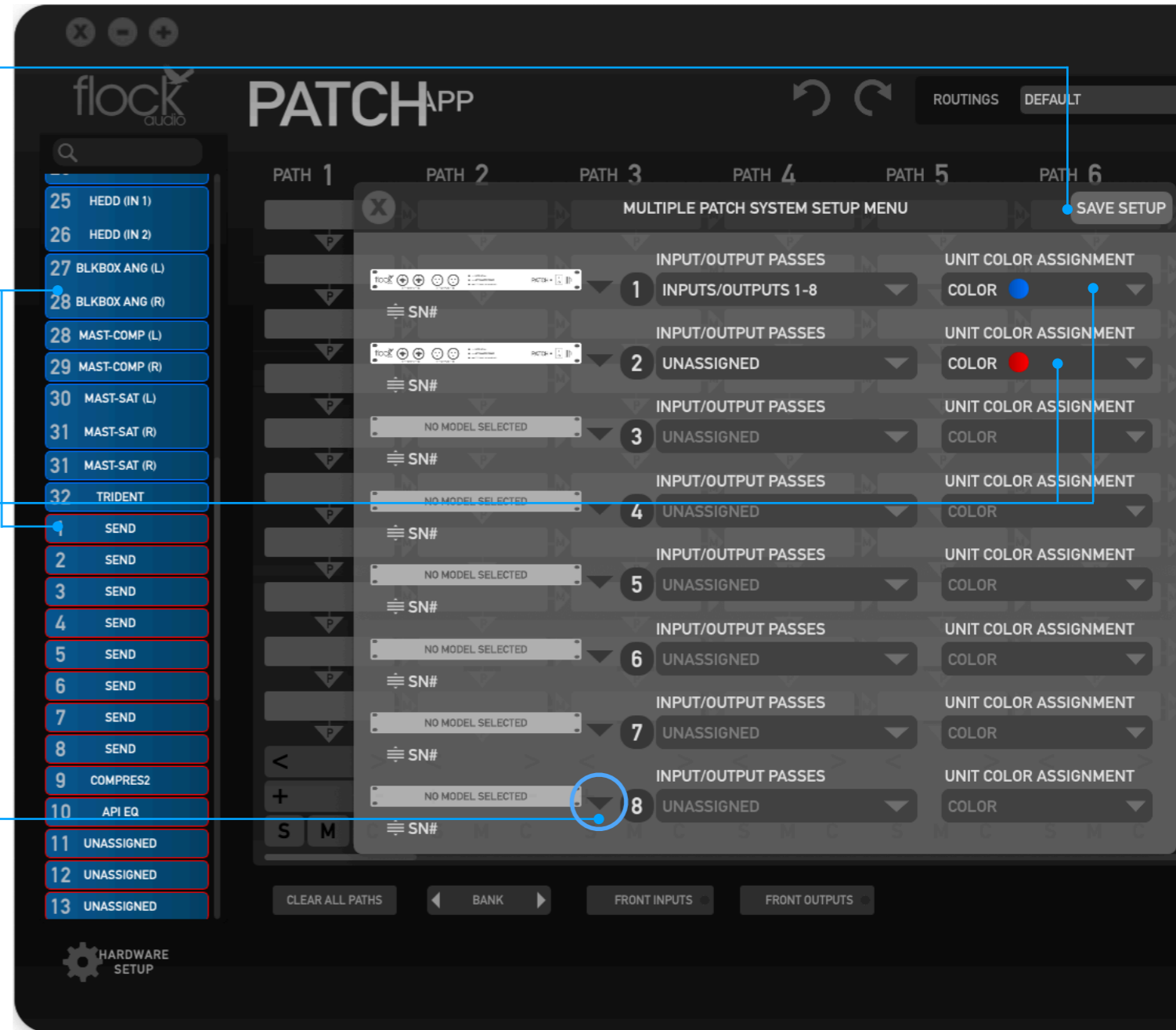
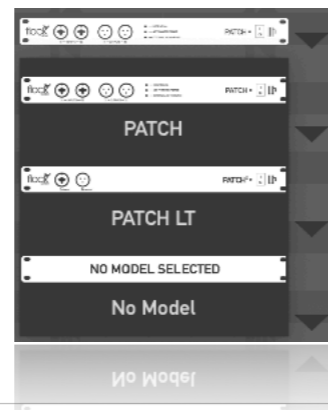





# MULTI-UNIT SETUP DIAGRAM

CONNECTING MULTIPLE PATCH MODELS FOR EXPANDED I/O

## MULTIPLE UNIT ANALOG CONNECTIONS

When connecting multiple hardware units together for Multi-Unit configurations, a user must choose which connections to configure in order to Send &/or Receive analog audio signals between multiple PATCH Hardware Units.

As shown in the right side example, 2 - PATCH Hardware Units are connected with 8 Sends and 8 Returns. This configuration example allows a user to Send 8 analog audio signals from one PATCH #1 to PATCH #2 and return 8 analog audio signals to PATCH #2 (if required).

This is only an example of the possible Multi-Unit routing configurations and is not restrictive of other user desired configurations. Users may choose to have more or all sends then equal returns.

The below example shows a simple PATCH APP Software view of what an Multi-Unit Hardware setup would appear like in the PATCH APP when routing from PATCH #1 to PATCH #2.



When Dragging + Dropping a SEND "Pass" into a signal flow digital rack space that is empty, the PATCH APP will populate both SEND & RECEIVE Digital Rack Spaces with color coded outlined Racks to allow the user to easily distinguish which PATCH unit is which.

## MULTIPLE PATCH UNIT SETUP MENU (PT.3)

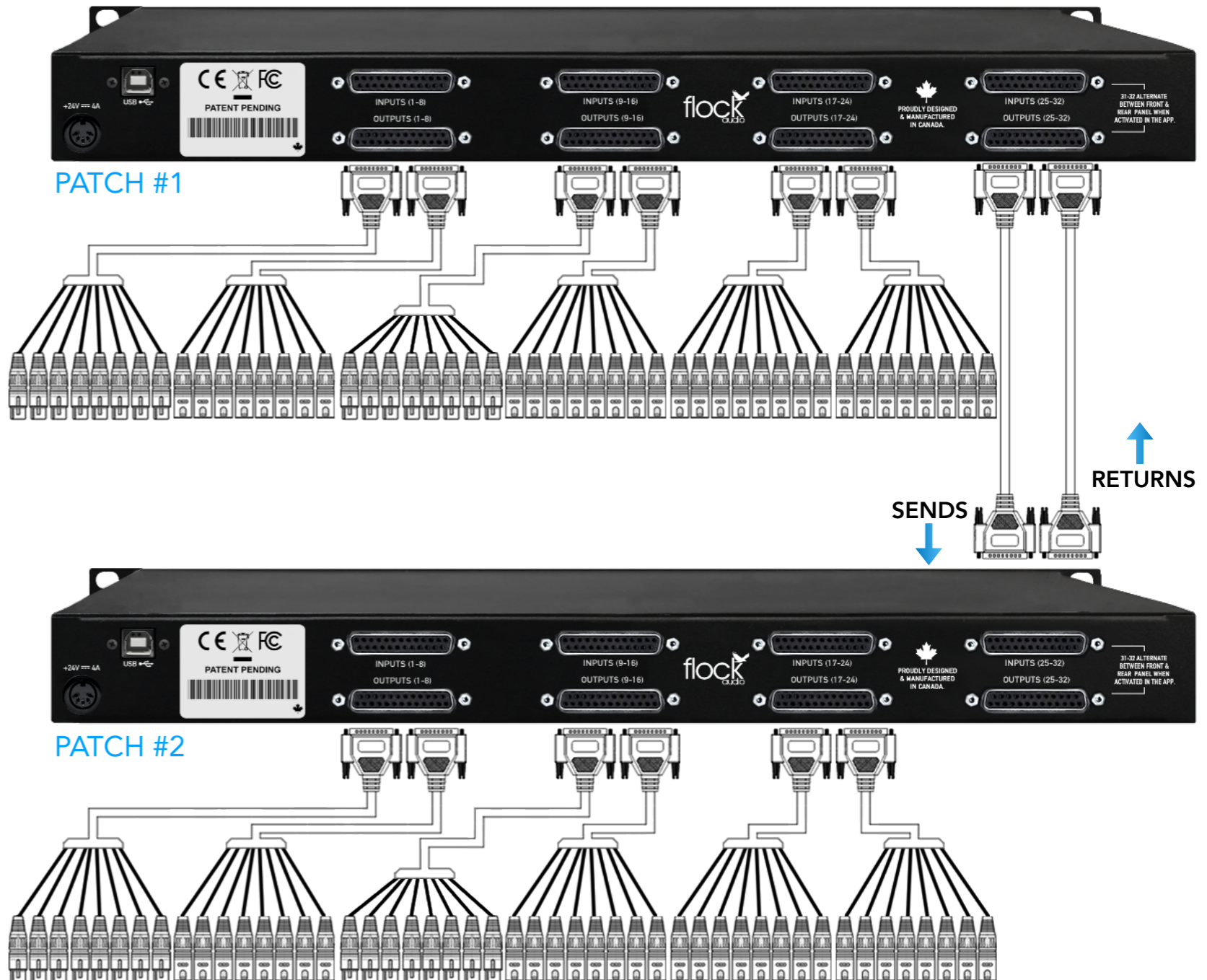

# UNDERSTANDING ANALOG VS. DIGITAL

UNDERSTAND THE DIFFERENCE...

CAN I CONNECT MY MULTIPLE PATCH SYSTEMS TOGETHER USING A USB OR THUNDERBOLT CABLE?

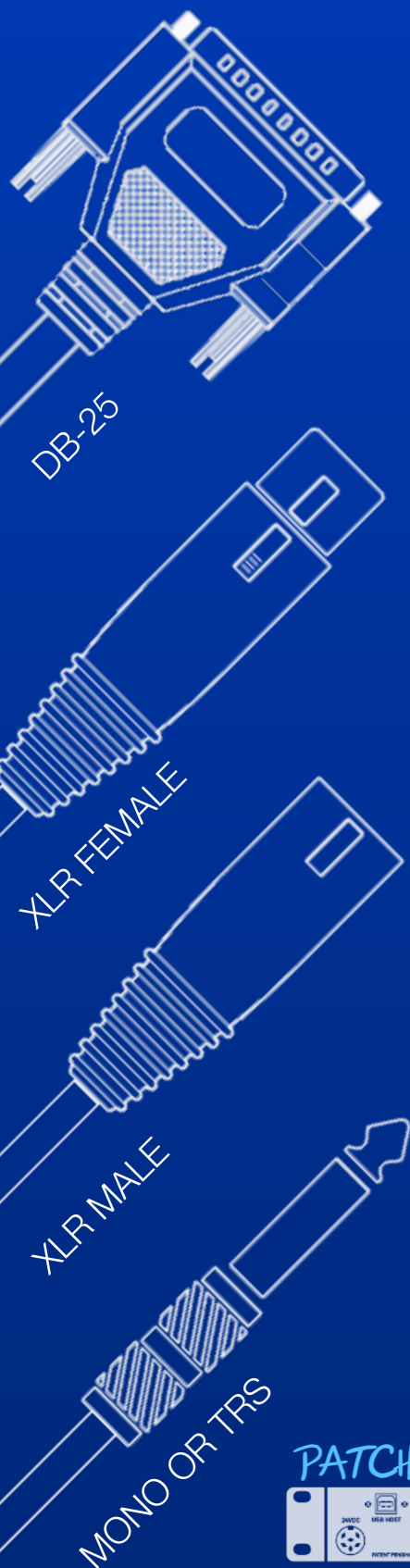

100% ANALOG

KEEPING IT ANALOG!

NOPE

WHY NOT?

PATCH HAS NO AD/DA CONVERSION

100% ANALOG ONLY

?

WHAT DOES THAT MEAN?

IN ORDER TO USE A DIGITAL CABLE (I.E. USB, THUNDERBOLT, ETHERNET, ETC.) TO PASS AUDIO THROUGH, THERE MUST BE A FORMAT CONVERSION FROM ANALOG TO DIGITAL REFERRED TO AS ADC - (ANALOG-to-DIGITAL CONVERTER).

BECAUSE **PATCH** IS COMPLETELY A PURE ANALOG ONLY ROUTING MATRIX WITH NO CONVERSION BUILT IN, MULTIPLE SYSTEMS REQUIRE A FORM OF ANALOG CABLE CONNECTION IN ORDER TO PASS AUDIO SIGNALS FROM ONE PATCH SYSTEM TO THE NEXT.

MULTIPLE **PATCH** UNIT ANALOG CONNECTIONS CAN BE CONFIGURED IN VARIOUS CONFIGURATIONS DEPENDING ON THE USERS DESIRED SETUP.

DIGITAL  
\*REQUIRES ADC

ADC USED IN RECORDING INTERFACES.

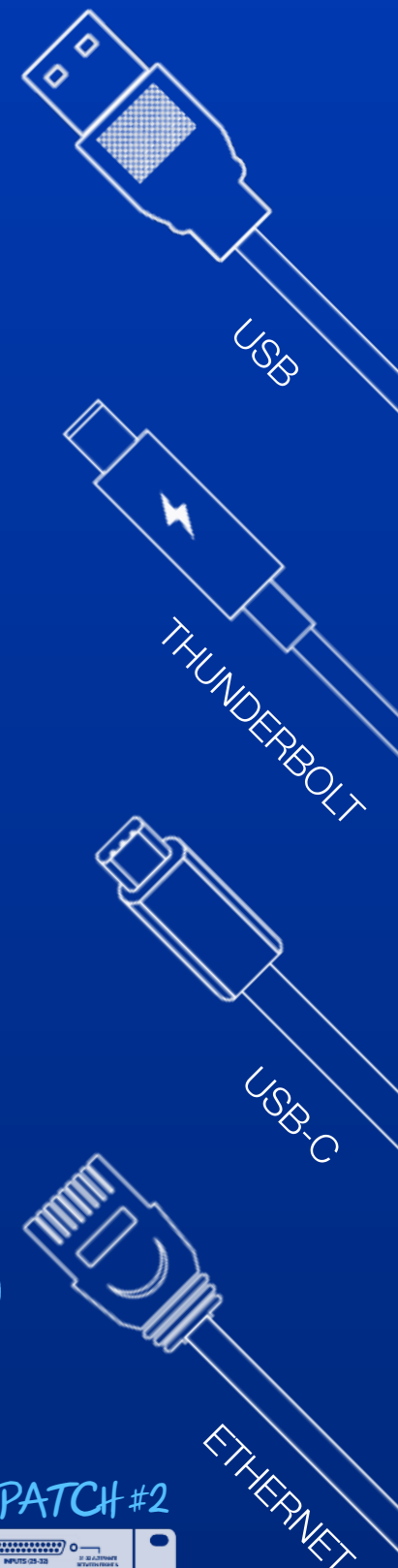

PATCH #1



ANALOG CONNECTION

EXAMPLE ONLY



PATCH #2

