

BM14S II – Owner's manual

DYNAUDIO
Professional

Introduction

Important safety instructions



The lightning flash with an arrowhead symbol within an equilateral triangle, is intended to alert the user to the presence of uninsulated “dangerous voltage” within the product’s enclosure that may be of sufficient magnitude to constitute a risk of electric shock to persons.



The exclamation point within an equilateral triangle is intended to alert the user to the presence of important operating and maintenance (servicing) instructions in the literature accompanying the product.

1. Read these instructions.
2. Keep these instructions.
3. Heed all warnings.
4. Follow all instructions.
5. Do not use this apparatus near water.
6. Clean only with dry cloth.
7. Do not block any ventilation openings. Install in accordance with the manufacturer’s instructions.
8. Do not install near any heat sources such as radiators, heat registers, stoves, or other apparatus (including amplifiers) that produce heat.
9. Do not defeat the safety purpose of the polarized or grounding-type plug. A polarized plug has two blades with one wider than the other. A grounding type plug has two blades and a third grounding prong. The wide blade or the third prong are provided for your safety. If the provided plug does not fit into your outlet, consult an electrician for replacement of the obsolete outlet.
10. Protect the power cord from being walked on or pinched particularly at plugs, convenience receptacles, and the point where they exit from the apparatus.
11. Only use attachments/accessories specified by the manufacturer.
12. Use only with the cart, stand, tripod, bracket, or table specified by the manufacturer, or sold with the apparatus.  When a cart is used use caution when moving

the cart/apparatus combination to avoid injury from tip-over.

13. Unplug this apparatus during lightning storms or when unused for long periods of time.
14. Refer all servicing to qualified service personnel. Servicing is required when the apparatus has been damaged in any way, such as power-supply cord or plug is damaged, liquid has been spilled or objects have fallen into the apparatus, the apparatus has been exposed to rain or moisture, does not operate normally, or has been dropped.
15. **WARNING:** To reduce the risk of fire or electric shock, this apparatus should not be exposed to rain or moisture and objects filled with liquids, such as vases, should not be placed on this apparatus.
16. To completely disconnect this equipment from the mains, disconnect the power supply cord plug from the receptacle.
17. The mains plug of the power supply cord shall remain readily operable.
18. **Danger:** To reduce the risk of electric shock, do not remove the back panel and do not expose the apparatus to rain or moisture. No user serviceable parts inside. Refer servicing to qualified personnel.

About this operating manual

Signal words

Caution – Indicates a potentially hazardous situation which, if not avoided, could result in damage to equipment.



CAUTION – Indicates in combination with a safety sign a potentially hazardous situation which, if not avoided, could result in minor or moderate injury or damage to equipment.



WARNING – Indicates in combination with a safety sign a potentially hazardous situation which, if not avoided, could result in death or serious injury.



DANGER – Indicates in combination with a safety sign a hazardous situation which, if not avoided, will result in death or serious injury.



等边三角形内带有箭头的闪电状符号意在提醒用户在产品的外壳内存在未绝缘的“危险电压”，电压可能很高，足以构成触电危险。



等边三角形内的感叹号符号意在提醒用户随产品一起的文字资料里有重要的操作和维护（维修）说明。

阅读这些说明。

保留这些说明。

注意所有的警告。

遵照所有的说明。

不要在靠近水的地方使用本设备。

只能用干布清洁设备。

按照制造商的说明进行安装。

不要在散热器、热风器、火炉或其他产生热量的设备（包括放大器）等热源附近安装使用本设备。

请勿破坏极性插头或接地型插头的安全保护性目的。极性插头有两个插片，其中一个比另一个宽。接地型插头有两个插片，另外还有一个接地插脚。极性插头的宽插片和接地型插头的接地插脚为您提供安全保障。如果提供的插头无法插入您使用的插座，请咨询电工，更换过时的插座。

防止电源线被踩踏或挤压，特别是插拔插头和插座时注意不要损坏与插头和插座连接处的电源线。

仅使用制造商指定的附件/配件。



仅使用制造商指定的或与设备一同出售的推车、支架、三脚架或桌子。当使用推车时，要小心移动与设备连在一起的推车，以免推车翻倒损坏设备。

遇雷雨天气或长时间不使用设备时，请拔下设备的插头。

请将所有维修事项交由有资质的售后服务人员完成。设备发生损坏时需进行维修，例如电源线或插头损坏，液体溅入设备或物体坠落到设备上，设备遭受雨淋或受潮，设备不能正常工作或被摔坏。

警告！

为了减少火灾或触电的危险，请不要让本设备遭受雨淋或液体溅洒，并确保设备上不放置任何盛有液体的物体，如花瓶。

请注意不同的工作电压需要使用不同类型的电源线和连接插头。

一定要遵守当地的安全规定。确保设备出厂设置功率要求（请参阅监听音箱背面的标签）与您所处地的市电电源相对应。

本设备应安装在靠近插座的地方，并确保能方便切断电源。

从交流电源插座拔下电源插头，以完全断开交流电源。

电源插座应保持随时可用状态。

不要将设备安装在密闭空间。

不要拆开设备，内有触电危险。

维修：

设备内没有用户可自行维修的部件。

所有维修必须由有资质的人员进行。

注意：

您必须注意未在手册中明确许可的任何变动或修改均可能导致您操作该设备无效。

此产品只适用于海拔2000m以下和非热带地区使用。



About this manual

This manual is divided in three main chapters, in which you can find all the information needed to operate the BM14S II successfully:

- **Before operation:** Learn all about unpacking and connecting the subwoofer. The controls and connections on the back panel are also described here.
- **Operation:** In this chapter you will learn how to operate the subwoofer in general and how to position it properly for optimum performance.
- **Optimizing settings/Troubleshooting:** Here detailed explanations can be found on how to optimize the settings in order to achieve the maximum sound quality.

Before operation

Unpacking the subwoofer

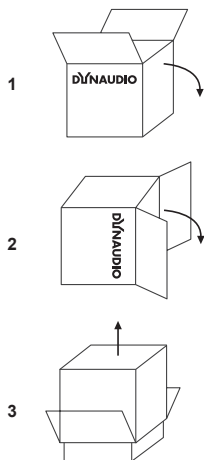

1. Unpack the subwoofer on a clean, even and soft area; floor carpeting is very suitable.
2. The packaging should be opened from the top (1). Remove all accessories that come packed with the subwoofer (such as AC power cord and grille). Do not remove the top part of the protective material.
3. With the protective material still in place but with accessories removed, carefully tilt the packaging on its side (1) and tilt again to turn it upside-down (2). Ensure that no part of the top-cover is obstructing the opening at the top.
4. The outer packaging can now be lifted away from the subwoofer itself (3). Remove the protective material that now is on top.
5. Open the bag and remove such from around the base of the subwoofer.
6. Again, carefully tilt the subwoofer on its side and again to turn it onto its feet. Note that the top part of the protective material will now come off easily so ensure that the subwoofer doesn't drop or slide away in the process.

Check that the contents are complete:

- **Subwoofer:** The factory-set power requirements (refer to label on rear of subwoofer) should correspond to the region where the subwoofer was purchased. You should also refer to the “Important safety instructions” on page 1.
- **Front baffle grille.**
- **AC mains lead.** The supplied lead should be suitable for the region where the subwoofer was purchased.
- This **owner's manual**.

Grille

The subwoofer can be operated without the grille. However, it is recommended that the grille is mounted during normal use to help prevent accidental damage or dirt settling on the cone of the loudspeaker. With subwoofers, the influence of the grille on the sound is virtually negligible.

To remove the grille:

- Gently pull the grille at all corners.

To fit the grille:

- Line up the studs with the corresponding front baffle holes. Gently push the grille in at all corners.

Note:

Be careful when mounting the grille not to touch the cone of the loudspeaker itself.

Controls and connections

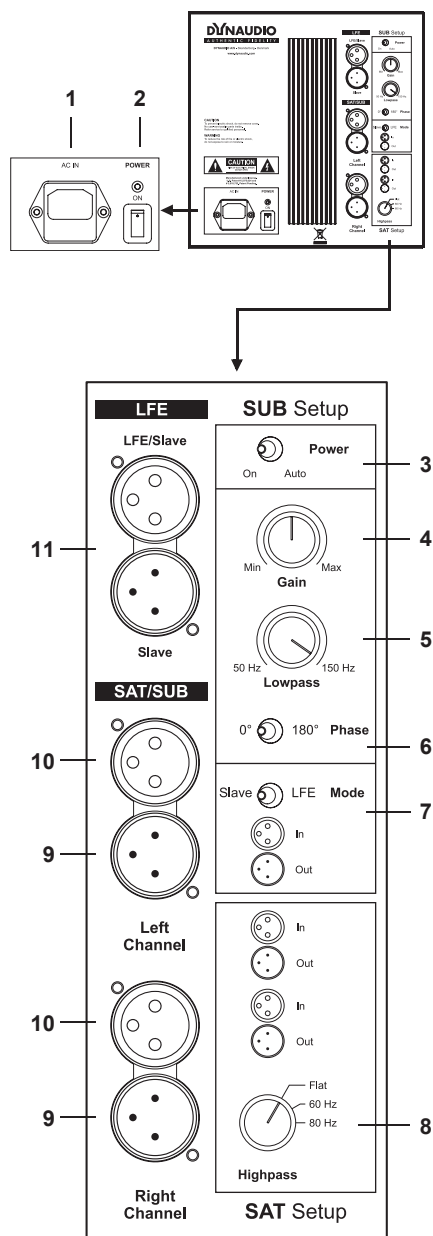

(1) AC IN

Mains power input.

(2) POWER ON (Main)

Main power switch (to switch the subwoofer manually on and off). LED shows operation mode:

- red: subwoofer switched on and in mute mode
- green: subwoofer is activated

(3) Power (Mode)

- On: subwoofer is permanently on
- Auto: subwoofer switches on when signal is detected

(4) Gain

Subwoofer volume level.

(5) Lowpass

Subwoofer lowpass frequency: continuously variable from 50 to 150 Hz.

(6) Phase

Phase setting: phase can be set to 0° or 180°.

(7) Mode

Subwoofer operation mode LFE or Slave:

- LFE: setting for normal use and Master use
- Slave: setting for second and all following subwoofers

(8) Highpass

Allows cutting off low frequencies of the signal provided at the SAT/SUB output:

- Flat: signal is not processed
- 60: cutoff frequency at 60 Hz
- 80: cutoff frequency at 80 Hz

(9) SAT/SUB (output)

Output for satellite system to be connected. This signal is processed according to the Highpass setting.

(10) SAT/SUB (input)

Input for full bandwidth signal. This signal will be processed according to the Highpass setting and provided at the SAT/SUB output.

(11) LFE

- LFE/Slave: input for LFE signal
- Slave: output to next subwoofer if installed

Terminal pinout (sockets 9, 10 and 11)

1 = 0

2 = +

3 = -

Connecting the subwoofer

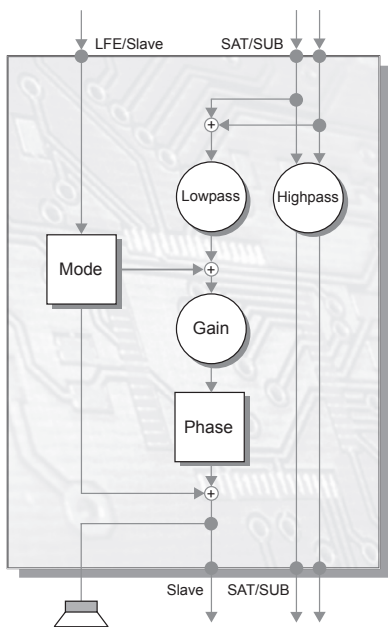

CAUTION

Damage due to improper connections!

Improper connections may damage the device.

- Set the mains power switch to OFF before connecting the BM14S II.
- Only switch the subwoofer on (mains power switch to ON) after all connections and set up steps have been properly completed.

Subwoofer inputs

The BM14S II provides two different signal inputs:

LFE/Slave

This input allows the LFE (Low Frequency Effect) channel to be connected. The signal is:

- reproduced by the subwoofer
- routed to the Slave output for a second subwoofer to be connected.

The Lowpass control has no impact on this input.

SAT/SUB

This input allows the connection of a full bandwidth signal. The signal is:

- reproduced by the subwoofer,
- routed to the SAT/SUB output terminals. Low frequencies are cut-off according to the Highpass setting,
- routed to the Slave output for a second subwoofer to be connected. High frequencies are cut-off according to the Lowpass setting.

Connecting a single subwoofer

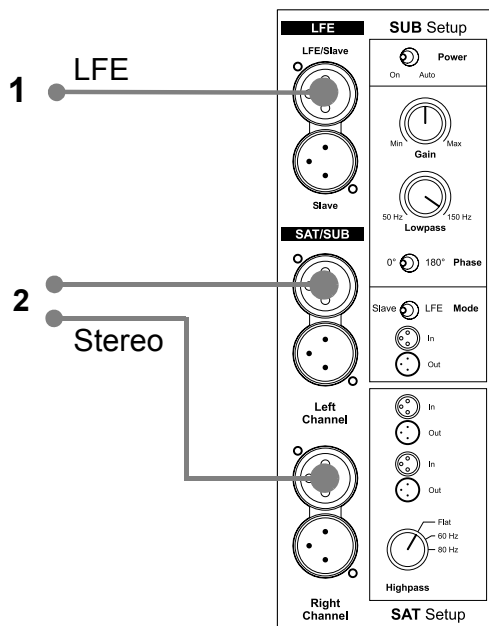

Connecting as LFE channel (1)

- Connect subwoofer to LFE/Slave input.

Connecting as subwoofer for satellites (2)

- Connect full bandwidth signal to SAT/SUB input.
Sub reproduces sum of right and left signal.
- Set the Mode switch to LFE.

Notes:

- You can also use both connection types. The signals will be combined in the BM14S II and routed accordingly. This allows the BM14S II to reproduce both the LFE channel information as well as the bass range of the connected satellite system.
- Use Slave mode if you want to use an external bass management system.

Multiple subwoofer connections

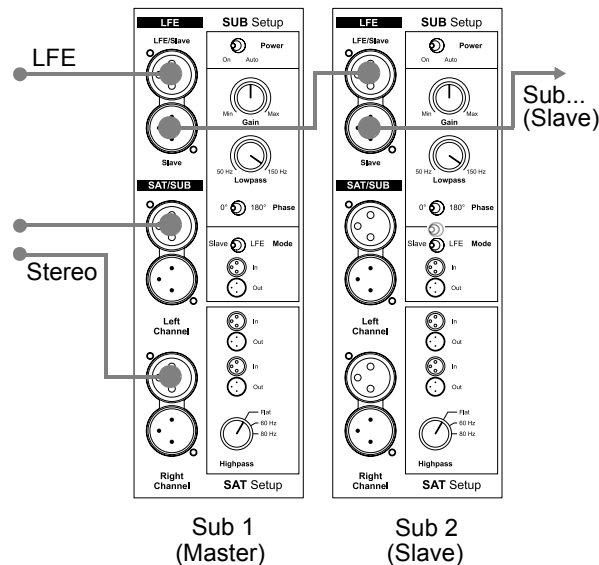

The BM14S II can be used stand-alone or together with multiple subwoofer units. Using multiple units may be helpful if the listening room is quite large or has difficult acoustic conditions. When using two or more subwoofers, the first one (designated “Master”) controls the following subs (designated “Slave”) via a subwoofer cable.

To connect multiple subwoofers:

1. Connect the first subwoofer as described before.
2. Set Mode switch of first subwoofer to LFE.
3. From the Slave output of the first subwoofer connect a XLR cable to the LFE/Slave input of the following subwoofer. This one now becomes the slave.
4. Set the Mode switch of the second subwoofer to Slave.

Further subwoofers can be connected in the same way. Set the Mode switch of all following subwoofers to Slave respectively.

Notes:

- When using multiple subwoofers in a Master-Slave setup, it is recommended that the subwoofers are all the same model.
- If you wish to use multiple subwoofers with full individual control, set the Input switch for all to the LFE position. From the source subwoofer output, use a Y-connector.

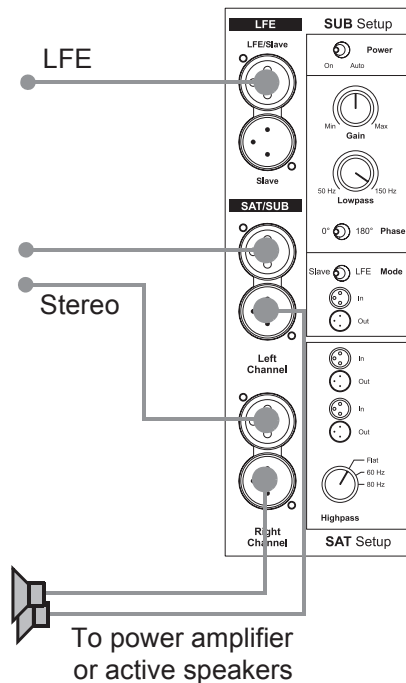
Connecting loudspeakers

If your source provides bass management, you can use the BM14S II's LFE input alone in LFE or SLAVE mode, depending on the management system capabilities. Avoid double processing if possible.

To connect loudspeakers

1. Connect the subwoofer (see "Connecting a single subwoofer" on page 8).
2. From the subwoofer SAT/SUB output connect a XLR cable to the inputs of the power amplifier you use for your speakers.

Note:

The signals connected to the inputs are provided at the Slave output for connecting another subwoofer. See page 8 to learn more about connecting multiple subwoofers.

Operation

Switching the subwoofer on

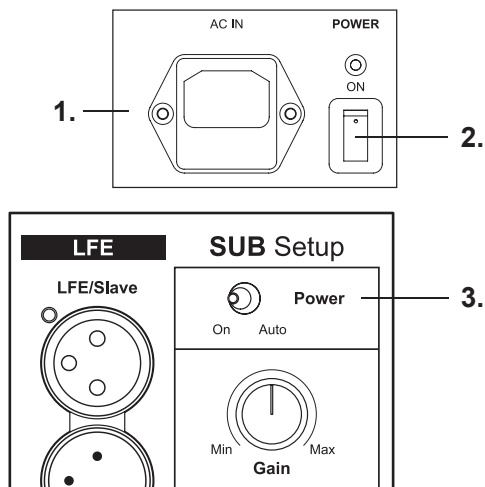

Once you have ensured yourself that all necessary connections have been made, the subwoofer and the connected components can be switched on.

1. Connect the subwoofer to the mains power.
2. Switch the subwoofer on with the main POWER switch on the rear panel. The status LED on the rear of the subwoofer will light up red.
3. Select a power mode with the Power switch on the rear panel.

Power modes

- **On:** the subwoofer is switched on permanently
- **Auto**
 - When a music signal is detected, the internal amplifier is activated automatically. The status LED on the back of the subwoofer will light up green. As long as a music signal is available on the subwoofer's input, it will remain switched on.
 - After 15 to 20 minutes of not sensing any input music signal, the subwoofer will switch itself to Standby

mode automatically. The status LED on the back of the subwoofer will light up red.

Note:

To switch the subwoofer completely off, set the main POWER switch to the OFF position.

Adjusting the volume (Gain)



CAUTION High Sound Levels!

High sound levels can cause auditory defects. To avoid auditory defects, do not listen to high sound levels over a longer period of time.

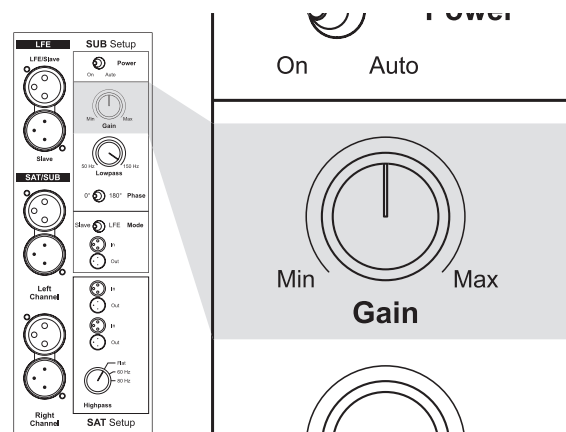

The correct volume setting is an important aspect in achieving a well balanced speaker combination.

To adjust the gain:

- Adjust the Gain control, until correct setting is reached.

Note:

You cannot adjust the volume when the subwoofer is in slave mode. In this case the volume is controlled by the setting of the master subwoofer.

Selecting the subwoofer cut-off frequency (Lowpass)

The Lowpass control allows the frequency range of the subwoofer to be defined. Above the selected frequency the sound level decreases rapidly. The correct setting of this cut-off frequency is important for a well balanced combination of subwoofer and speakers.

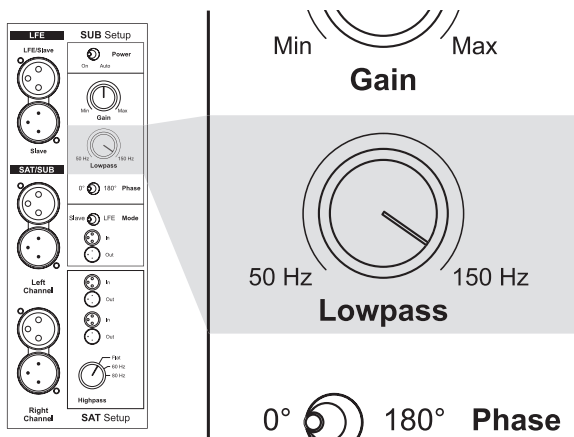

To select the cutoff frequency

- Set the Lowpass control to the desired frequency between 50 and 150 Hz.

Note:

- The Lowpass only works on SAT/SUB input.
- Perhaps subwoofer cut-off frequency is already set in the bass management of your source. Please refer to the operating manual of your source. In general use only one bass management system.

You should also heed the instructions given in the operating manual of your loudspeakers.

Setting the phase (Phase)

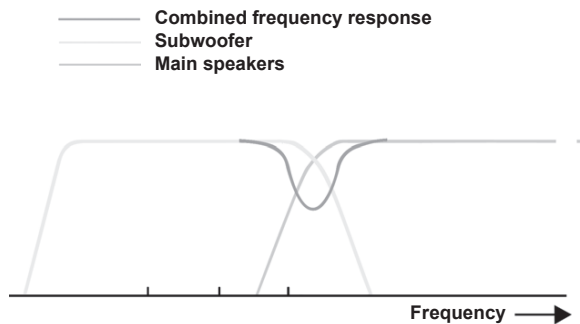

With the phase settings you can adjust the phase relationship between the subwoofer and main speakers. If either subwoofer or main speaker are slightly out of phase in relation to the other, it can result in decreased bass output in the frequency response area where they overlap each other.

The phase relationship between subwoofer and satellite speakers is very dependent on relative distance, construction and working principles of the main speakers. The figure on the left shows a case whereby phase of the subwoofer and main speakers are incorrect in the critical overlap area, thus significantly reducing acoustic output in the listening room in that area.

To find the correct phase setting:

1. Play a bass-rich track which also covers the overlap area.
2. Toggle the Phase switch between 0° and 180°.
 - Choose the setting for which you experience the most bass.

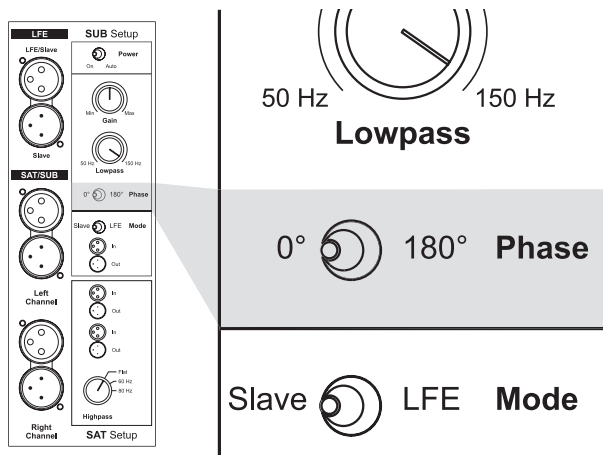
**Note:**

You can not set the phase if the subwoofer is in slave mode. In this case the phase is controlled by the setting of the master subwoofer.

Setting the satellite cut-off frequency (Highpass)

Depending on the bass capabilities of the speakers, the frequency range of subwoofer and speakers can overlap between 50 Hz and 150 Hz. A bump or a gap in the frequency response and thus a lower sound quality will be experienced if the system is not matched properly. In addition, small speakers and low powered amplifiers will particularly be affected by the low frequency signals, which again has a negative effect on the sound quality. Therefore it makes sense to limit the bass range of the connected speakers (called “satellites” in this case) by a highpass filter. The BM14S II provides three settings to achieve this:

- **Flat** = no limitation
- **60 Hz** = frequencies below 60 Hz are cut off.
- **80 Hz** = frequencies below 80 Hz are cut off.

To set the cut-off frequency

- Switch Highpass control to needed position.

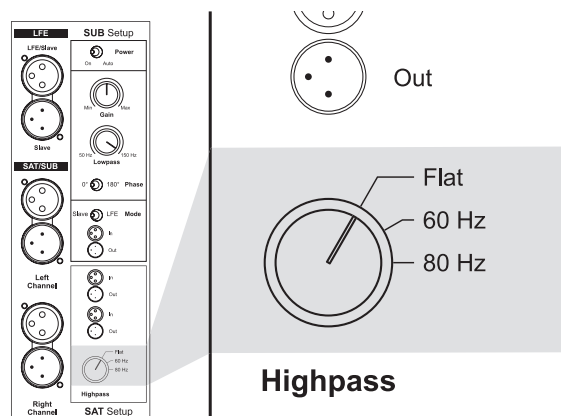

Troubleshooting

There may be various reasons why the subwoofer doesn't function properly in a system without it being faulty. The checklist below will help solve problems you may encounter. Before consulting your Dynaudio Professional dealer, check this list first.

Check this first:

- Check if all signal cables are connected properly.
- Check settings in bass management menu of the connected source.
- Carefully and gradually increase the subwoofer volume level on the source.
- Carefully and gradually increase the subwoofer volume level on the subwoofer Gain control.

Problem	Cause	Solution
The subwoofer switches itself off while music is being played.	There is hardly any low-frequency signal available in the signal. This can happen if the music or movie itself does not contain very low frequencies (e.g. long dialogues).	<ul style="list-style-type: none"> – The subwoofer will switch on automatically as soon as low frequent music signals are detected. – Switch subwoofer off and on again by means of the main POWER switch.
The subwoofer will not switch on at all.	<ul style="list-style-type: none"> – AC mains cable has become disconnected (LED does not lit) – Mains switch on the back is switched to OFF (LED does not lit) 	<p>Make sure to switch the system off first before making any changes!</p> <ul style="list-style-type: none"> – Reconnect mains cable. – Switch mains back on. – Check if all signal cables are connected properly.
The subwoofer will not switch on automatically.	– No signal is present on either of the subwoofer's inputs (LED lights red).	<p>Make sure to switch the system off first before making any changes!</p> <ul style="list-style-type: none"> – Check if all signal cables are connected properly. – Check if the subwoofer output on the source is engaged.
Subwoofer is switched on but no sound from the subwoofer.	<ul style="list-style-type: none"> – No signal is present on either of the subwoofer's inputs. – In the source's bass-management set-up, subwoofer has been disabled. – Subwoofer volume level has been turned down all the way on the source. – Subwoofer volume level has been turned down all the way with the subwoofer's control. 	<p>Make sure to switch the system off first before making any changes!</p> <ul style="list-style-type: none"> – Check if all signal cables are connected properly. – Check settings in bass management menu of the source. – Carefully and gradually increase the subwoofer volume level on the source. – Carefully and gradually increase the subwoofer volume level on the subwoofer Gain control.

Maintenance

Cleaning the subwoofer

Dynaudio loudspeakers require no special treatment apart from the kind of careful handling you would normally apply to any high tech product in your home.

DANGER

Dangerous voltage inside!

Cleaning the BM14S II or other system components when switched on can lead to damages or electric shock.

- Switch off the subwoofer and all other components of your system when cleaning any of these components.

To clean the subwoofer:

- The cabinet and other plain parts should be cleaned with a soft dry or slightly damp cloth.
- Dust on the woofer diaphragms may be removed with a fine furniture brush.

Note:

Avoid touching the tweeter domes as any change of their shape may have an impact on sound quality.

Changing the fuse



WARNING

Risk of fire due to wrong fuse type!

Inserting the wrong fuse type can lead to overheating and inflammation of the subwoofer.

- For continued protection against risk of fire, replace only with same type fuse and rating.

The fuse is placed on the rear of the subwoofer below the mains power input. It can be changed without removing the amplifier module.

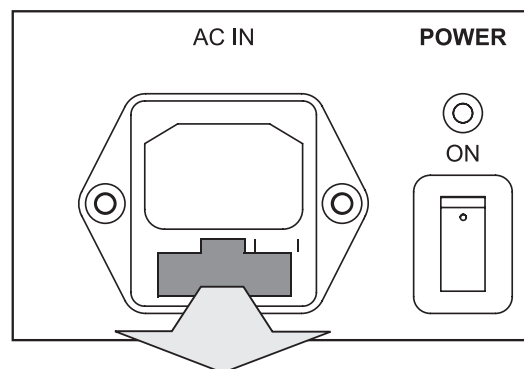

To change the fuse:

1. Switch off the mains power switch and unplug the power cable.
2. Pull out the fuse holder.
3. Replace fuse with same type and rating.
4. Push fuse holder back firmly until it is locked into position.

Warranty

Dynaudio Professional products are warranted to be free from defects in components and factory workmanship under normal use and service for a period of two (2) years when bought from a reseller within the EU.

Dynaudio Professional products are warranted to be free from defects in components and factory workmanship under normal use and service for a period of one (1) year when bought from a reseller outside the EU.

When failing to perform as specified during the warranty period we will undertake to repair, or at our option, replace this product at no charge to its owner, provided the unit is returned undamaged and shipping prepaid, to an authorized service facility or to the factory.

Dynaudio shall not be responsible for any incidental or consequential damages. Dynaudio's responsibility is limited to the product itself. Dynaudio assumes no responsibility for any loss due to cancellation of any events, or rent of replacement equipment or costs due to third party's or customer's loss of profit, or any other indirect cost or losses however incurred.

Dynaudio reserves the right to make changes or improvements in design or manufacturing without assuming any obligation to change or improve products previously manufactured and / or sold.

The product warranty is only valid in the country where the product was purchased.

Exceptions

Dynaudio will always follow the law of the respective markets should it differ from the policy stated above or the exceptions stated below.

This warranty shall be null and void, if the product is subjected to repair work or alteration by a person or facility other than those authorized by Dynaudio; mechanical damage including shipping accidents; war, civil insurrection, misuse, abuse, operation with incorrect AC voltage, incorrect connections, wrong accessories, incorrect use of accessories, operation with faulty associated equipment, exposure to inclement weather conditions and normal wear and tear.

Units, on which the serial number has been removed or defaced, are not eligible for warranty service.

Technical Specifications

System	Active subwoofer
Bass principle	Closed
Frequency response	18 Hz to 250 Hz (± 3 dB)
Inputs – LFE/Slave	XLR
Inputs – SAT/SUB	Right/left full bandwidth, XLR
Input impedance – + branch	20 kOhm
Input impedance – - branch	10 kOhm
Max. input voltage	10 VRMS
Outputs – Slave	XLR
Outputs – SAT/SUB	Right/left, Highpass filtered, XLR
Output impedance	100 Ohm (each branch)
XLR Pinout	1 = 0 / 2 = + / 3 = -
Mode selector	LFE, Slave (Phase and volume controls are bypassed in slave mode)
Phase adjustment	0°, 180°
Highpass	Flat, 60 Hz, 80 Hz
Lowpass	50 Hz to 150 Hz
Power modes	On, Auto
Amplifier power	300 W, 4 Ohm
Power consumption – Standby	< 0.5 W
Power consumption – max.	325 W
Woofers – Cone	300 mm / 12", long throw, one piece molded MSP (Magnesium Silicate Polymer) cone
Woofers – Coil	75 mm / 3", pure aluminum voice coil
Dimensions, external (Depth x Width x Height)	412 x 350 x 350 mm (incl. cloth cover)
Cabinet volume	31 liters
Weight	18,4 kg
Mains – 100-120 V / 220-240 V, 50/60 Hz	1 Fuse = 3.15 A

Due to continuous development, these specifications are subject to change without notice.



© **Dynaudio A/S, 8660 Skanderborg, Denmark**

Owner's Manual BM14S II 0214 – item no. 455408

All text and image copyrights reserved. Subject to change without notice.

www.dynaudioprofessional.com