



USER MANUAL v1.7

connect with us.



facebook.com/audient
twitter.com/audientworld
youtube.com/audienthampshire

www.audient.com

Thank you for purchasing this *audient* product!

iD22 is the culmination of years of experience in high-performance analogue and digital circuit design.

iD22 will transform your DAW into a world-class recording system by connecting directly to your microphones, computer and monitors.

iD22 provides two classic *audient* (class-a) microphone preamplifiers, ALL NEW pristine AD/DA converters that have been designed to deliver impeccable detail and impressive depth during both tracking & mixing.

iD22 is expandable via ADAT i/o - perfect for partnering with an ASP008 for 10-ch recording (total 10-in, 12-out + headphones).

Our console-style monitor controller functionality and USB2.0 connectivity complete the ergonomic desktop package.

Features include:

- 2-in, 6-out high performance 24-bit/96kHz AD/DA converters
- 2 x superb class-a mic preamplifiers & 1 x discrete JFET instrument input
- Fully balanced insert points for integrating outboard gear
- High current headphone amplifier fed by an independent DAC
- 4 assignable line outputs for monitoring & processing
- User defined monitoring functionality with hardware control
- USB2.0 class compliant connectivity with integrated DSP mixer
- Ergonomic desktop package featuring all metal construction and solid aluminium control knobs



Box Contents	1	System Panel - Settings Module	27
iD22 Overview	2	Digital I/O Formats	27
Safety Information	3	Clock Source & Lock	27
Declaration of Conformities	5	Talkback Assign	27
Quick Start Installation:	6	Mono Monitoring Modes	27
System Requirements	6	Dim & Alt. Speaker Trims	27
Connection to Computer	6	Setting Up & Using Talkback	28
Installation on Mac OSX	6	Output Routing Matrix	29
USB Status LED	7	Analogue Outputs	29
Audio MIDI Setup (OSX)	7	Digital Outputs	29
Installation on Windows	8	Save & Load Mixer Presets	30
Updating Firmware	10	iD DSP Mixer Block Diagram	31
Hardware Features:	11	Keyboard Shortcuts	32
Microphone & Line Inputs	11	Operation with Pro Tools	33
Instrument Input	12	Operation with Logic Pro	34
Balanced Inserts	12	Operation with Cubase / Nuendo	36
Direct ADC Access	13	Operation with Ableton Live	38
Input Stage Block Diagram	14	Troubleshooting	39
Assignable Line Outputs & DAC	15	FAQ	41
Output Routing Ideas	16	Specifications	42
Headphone Output	17	Dimensions	43
Digital Inputs / Outputs	18	Warranty & Contact	44
Monitor Control Section	19	Service	45
Switch Operation	20	Glossary	46
Metering & Kensington Lock	20		
Output Stage Block Diagram	21		
iD Mixer Application:	22		
Input Channel Types	22		
Channel Naming Tape	22		
Channel Strip Features	23		
Stereo Linking	24		
Master Section Features	24		
Channel Views	25		
Volume Control	25		
Programming F Keys	26		

In your iD22 packaging you should find the following items:

- iD22
- 12VDC PSU with regional adapters
- USB Type A-to-B Cable

Please visit:

www.audient.com/products/iD22

to download the latest iD software (firmware and mixer application), supporting documentation (including this manual) and brochures for our product range.

The 12VDC (centre-positive) power supply comes with interchangeable UK, EU, US and Australian socket adapters and will work across a broad range of line voltages making iD22 globally portable.

We hope that you enjoy using iD22 wherever you are and may it aid you in making great sounding music!



Actual PSU & USB cable may differ from images.

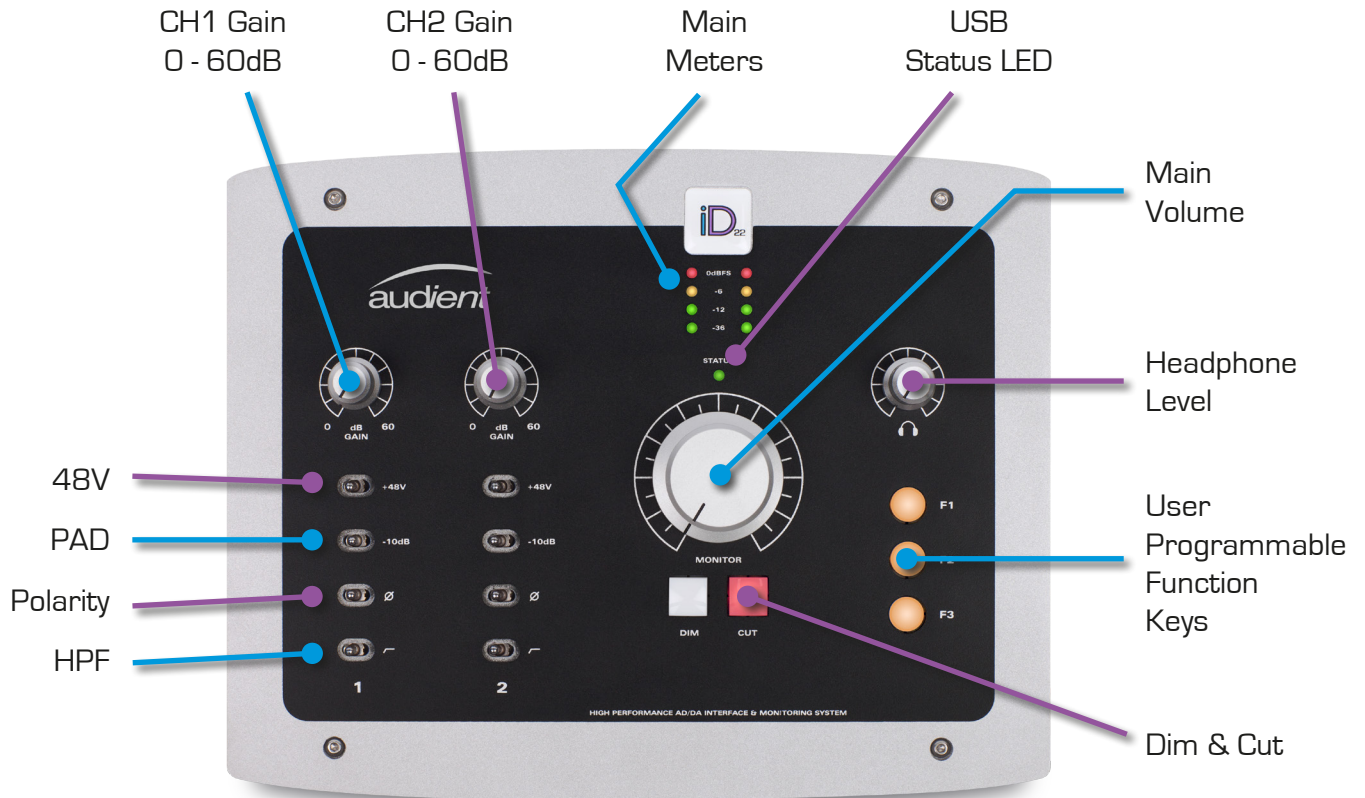

Important Safety Instructions

Please read all of these instructions and save them for later reference before connecting the DC power adapter to the mains and powering up iD22.

To prevent electrical shock and fire hazard follow all instructions on the 12VDC power supply. iD22 itself does not operate with any high voltage mains supply inside the unit but appropriate safety measures should still be adhered to regarding the AC/DC supply.

In the event of a power supply failure do not open the 12VDC supply. Please contact *audient* support so that a suitable replacement can be recommended or purchased.

www.audient.com/support

iD22 utilises an external switch-mode power supply that is very quiet and rated at 1.5A (2A maximum, 24 Watts). This switch-mode design will accept any A.C line voltage from 90v to 264v @ 47-63Hz. Therefore the unit will work happily anywhere in the world but please ensure your A.C mains line voltage is within this specification.

Consult a qualified technician if you suspect difficulties. Do not attempt to tamper with the power supply or mains voltages - **HAZARDOUS TO HEALTH**. Ensure that the appropriate international pin adapter is fitted to the power supply before insertion into the mains socket.

! WARNING !

TO REDUCE RISK OF FIRE OR ELECTRIC SHOCK, DO NOT EXPOSE THIS APPARATUS TO RAIN OR MOISTURE.

NO USER SERVICEABLE PARTS INSIDE.
PLEASE REFER SERVICING TO QUALIFIED SERVICE PERSONNEL.

Important Safety Instructions

1. Read these instructions
2. Keep these instructions
3. Heed all warnings
4. Follow all instructions
5. Do not use this equipment near water
6. Clean only with dry cloth
7. Do not block any ventilation openings. Install in accordance with the manufacturer's instructions
8. Do not install near any heat sources such as radiators, heat registers, stoves, or other equipment (including amplifiers) that produce heat
9. Do not defeat the safety purpose of the polarized or grounding-type plug. A polarized plug has two blades with one wider than the other. A grounding type plug has two blades and a third grounding prong. The wide blade or the third prong are provided for your safety. If the provided plug does not fit into your outlet, consult an electrician for replacement of the obsolete outlet
10. Protect power cords from being walked on or pinched particularly at plugs, convenience receptacles, and the point where they exit from the equipment
11. Only use attachments/accessories specified by the manufacturer
12. For products that are not rack-mountable: Use only with a cart, stand, tripod, bracket, or table specified by the manufacturer, or sold with the equipment. When a cart is used, use caution when moving the cart/equipment combination to avoid injury from tip-over
13. Unplug this equipment during lightning storms or when unused for long periods of time
14. Refer all servicing to qualified service personnel. Servicing is required when the equipment has been damaged in any way, such as power-supply cord or plug is damaged, liquid has been spilled or objects have fallen into the equipment, the equipment has been exposed to rain or moisture, does not operate normally, or has been dropped
15. For products that are a mains powered device: The equipment shall not be exposed to dripping or splashing and no objects filled with liquids (such as vases) shall be placed on the equipment

FCC Part 15B

This apparatus has been tested and found to comply with the limits of a class-a digital device, pursuant to Part 15B of the FCC Rules. These limits are designed to provide reasonable protection against harmful interference in a residential installation. This equipment generates, uses and can radiate radio frequency energy and, if not installed and used in accordance with the instructions, may cause harmful interference to radio communications. If this equipment does cause harmful interference to radio or television reception, which can be determined by turning the equipment off and on, the user is encouraged to try to correct the interference by one or more of the following measures:

1. Re-orient or relocate the receiving antenna
2. Increase the separation between the equipment and receiver
3. Connect the equipment into an outlet on a different circuit from that to which the receiver is connected
4. Consult the dealer or an experienced radio/TV technician for help

We, Audient Ltd, Aspect House, Herriard, Hampshire, RG25 2PN, UK, 01256 381944, declare under our sole responsibility that the product iD22 complies with Part 15 of FCC Rules.



Operation is subject to the following two conditions:

1. This device may not cause harmful interference, and
2. This device must accept any interference received, including interference that may cause undesired operation



We, Audient Ltd, declare that the product, the iD22, to which this declaration relates, is in material conformity with the appropriate CE standards and directives for an audio product designed for consumer use.



Audient Ltd has conformed where applicable, to the European Union's Directive 2002/95/EC on Restrictions of Hazardous Substances (RoHS) as well as the following sections of California law which refer to RoHS, namely sections 25214.10, 25214.10.2, and 58012, Health and Safety Code; Section 42475.2, Public Resources

System Requirements

- OSX: 10.6.8 (Snow Leopard) or later
- Mac: Intel CPU, 1GB RAM Minimum

1. Download the Latest iD Software

Head straight to our website for the latest version of our iD mixer Mac Installer:

www.audient.com/products/downloads/iD22

Run the installer and follow the on-screen instructions. It is recommended that you restart your computer after installation to allow all settings to take affect.

2. Connect iD22

Using the USB cable provided, connect iD22 to your computer's USB port.

Next power on iD22 by connecting the supplied 12VDC power adapter.

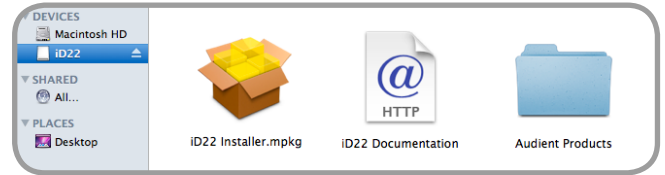

3. Status LED

Once powered on and connected to your computer via USB, the green status LED on iD22 will flash for a few seconds as the unit stabilises and establishes communications.



This LED will become solidly lit as soon as iD22 has achieved stable communication and should remain solidly lit during operation of the unit until power down. Once solidly lit you can launch the iD mixer application without issue.

If at any time the status LED begins to flash during normal operation please check all connections and if further problems develop please contact [audient support](#).

4. Double Checking Connectivity

To ensure iD22 has been detected by your computer and correct clocking sources are set-up, navigate to:

[Macintosh HD > Applications > System Preferences](#)

Check that iD22 is set as your i/o device. It is recommended to disable system sounds.

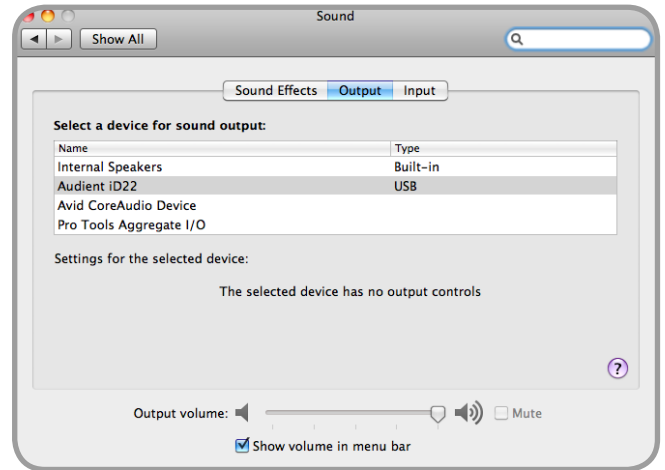

It is also worth checking [Audio MIDI Setup](#) [found in [Mac HD > Applications > Utilities](#)].

[Window > Show Audio Window](#)

Here you should see iD22 report with 10 inputs and 14 outputs. Clock source should be set to [Audient Internal Clock](#) unless you are connecting an external digital device acting as master to the digital input in iD22.

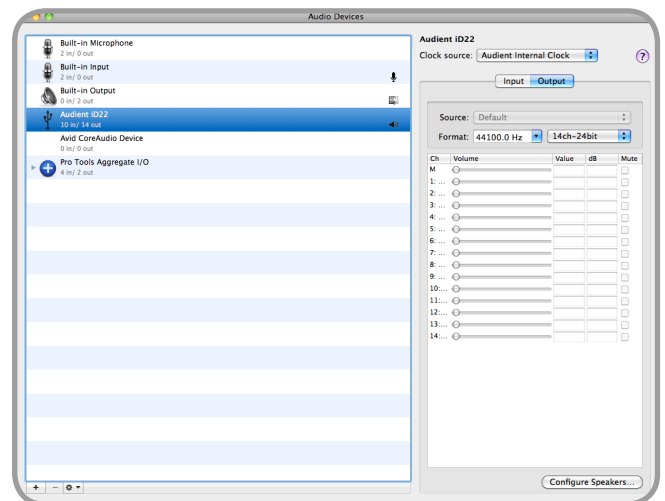

System Requirements:

- Windows 7 or later (32 and 64 bit)
- PC or laptop manufactured after January 2006
- Intel Core 2 @ 1.6 GHz, or AMD equivalent
- 1 GB RAM Minimum

1. Download the latest iD22 Software

Head straight to our website for the latest version of our iD Windows Installer:

www.audient.com/products/downloads/iD22

Extract the Zip into a temporary location on the computer.

2. Connect iD22

Using the USB cable provided, connect iD22 to your computer's USB port.

Next power on iD22 by connecting the supplied 12VDC power adapter.

3. Run iD22 Setup

Locate setup.exe in the extracted folder and open it to start the installation wizard. Follow the onscreen instructions.

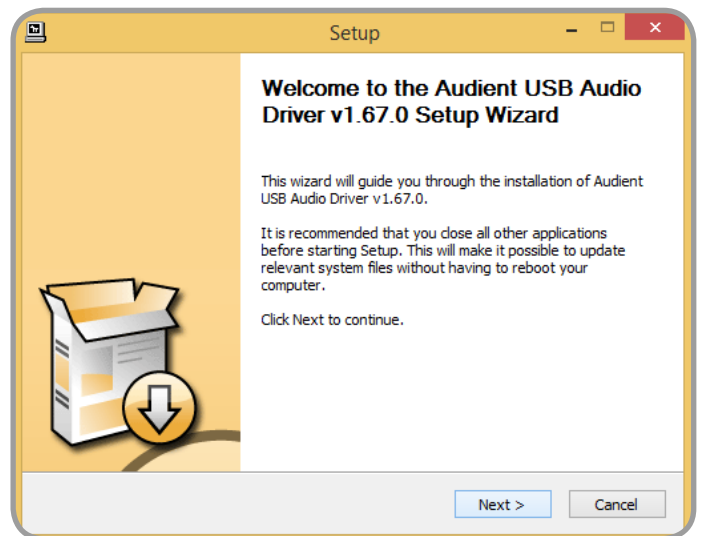
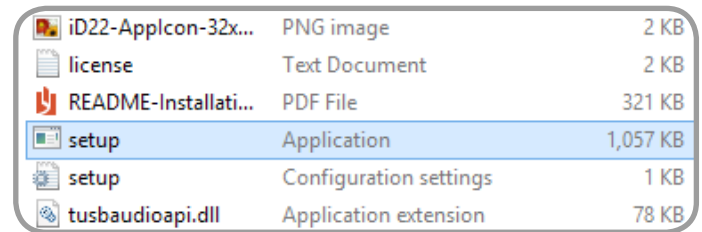
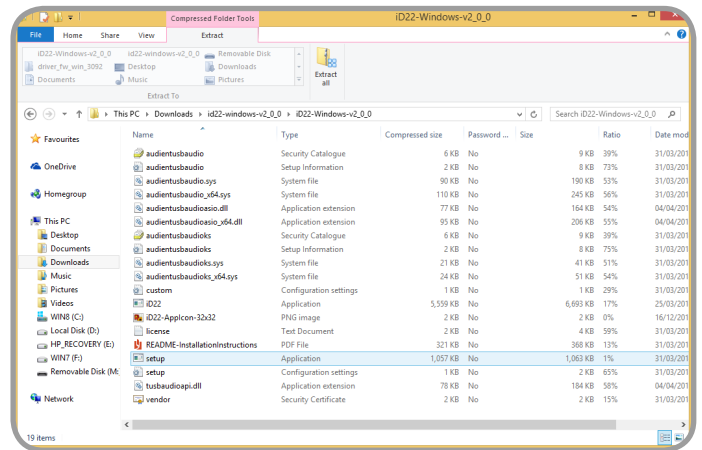

4. Check Connectivity



The status LED will become solidly lit as soon as iD22 has achieved stable communication and should remain solidly lit during operation of the unit until power down.

To double check go to PC sound settings by following:

PC Settings > Control Panel > Hardware and Sound > Sound

Here you can see whether iD22 is visible to the PC and you can make it the computers default sound device by pressing Set Default.

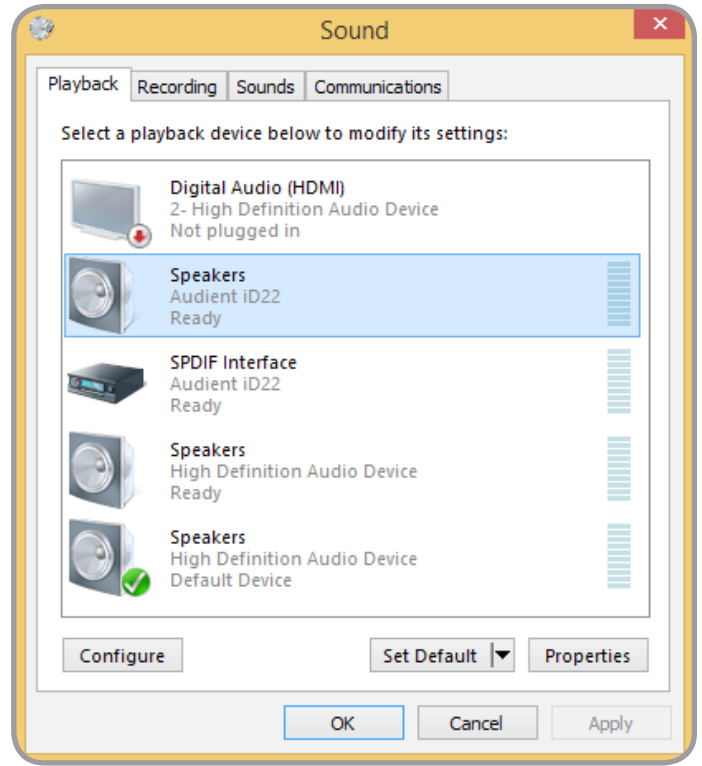

iD Icon

Once installed, the iD icon can be found in the Windows system tray (it may be in the hidden icons area):

- Double-click to open iD22 mixer window when iD22 is connected
- Right-click to quit or change sample rate, buffer size and latency settings

Latency Modes:

Minimum	1 ms
Low	2ms
Standard	4 ms
Relaxed	8ms
Safe	16ms
Extra Safe	32ms

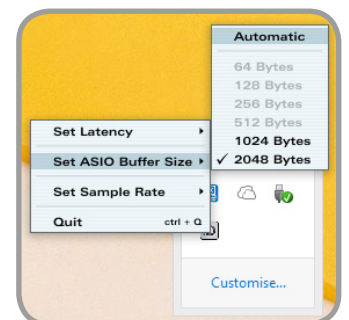
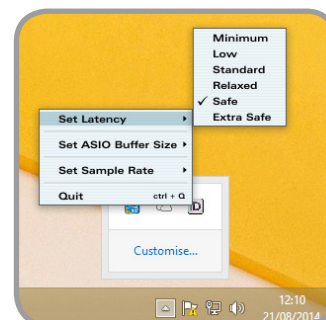

Launch the iD Mixer Application

Launch the iD22 mixer application by finding it in the following folder:



Macintosh HD > Applications > iD22
Start > All Programs > Audient > iD22

If the iD mixer application icon is not in your dock, just drag it onto the dock from the applications folder.

For more information on the mixer application feature set, please refer to page 22 of this manual onwards.



Check for Firmware Updates

It is essential that you regularly (especially on a fresh installation) check for new updates. To make it simple, providing you have an internet connection, the iD mixer application itself provides the functionality to check for firmware updates.

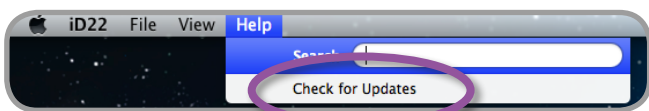

Firmware Update

You can either select to update the iD firmware from disk using the load from file (browse button) or you can use the internet to search for the latest version.



The latest version number will be retrieved from our servers and will be displayed (as shown above). Press next to continue with the firmware update. Press **update** to program and once complete close the window. iD22 is now ready to use.

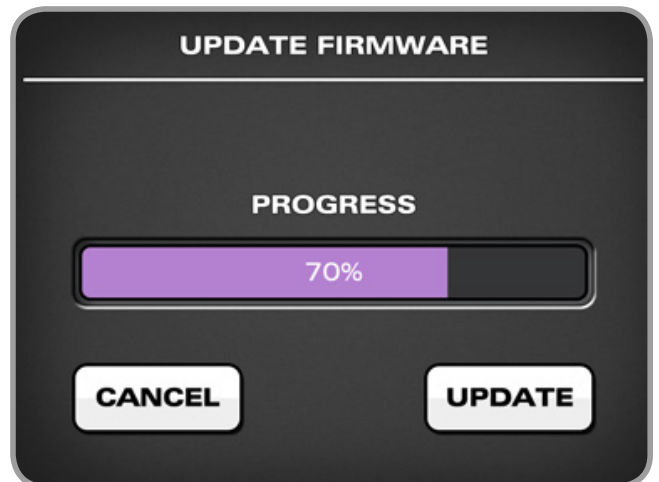

Microphone Preamplifiers & Line Inputs

iD22 features two classic *audient* microphone preamplifiers.

The design features an 8-transistor discrete class-a front-end providing exceedingly low distortion and noise performance. From a sonic point of view, iD22 is fast, open and detailed.

All analogue circuitry runs on +/-15V (30V rails) and provides high headroom and class leading drive capability compared to other similar interface products.

The microphone preamplifiers feature:

- 60 dB of clean gain
- 48v phantom power rated at 10mA/channel
- > 3kΩ input impedance which provides a punchy tone from any microphone transducer type
- -10 dB pad for increasing input headroom
- Polarity reverse (always check phase when recording with multiple microphones)
- Switchable (fixed frequency) 100Hz 12 dB/octave high pass filter for rumble removal

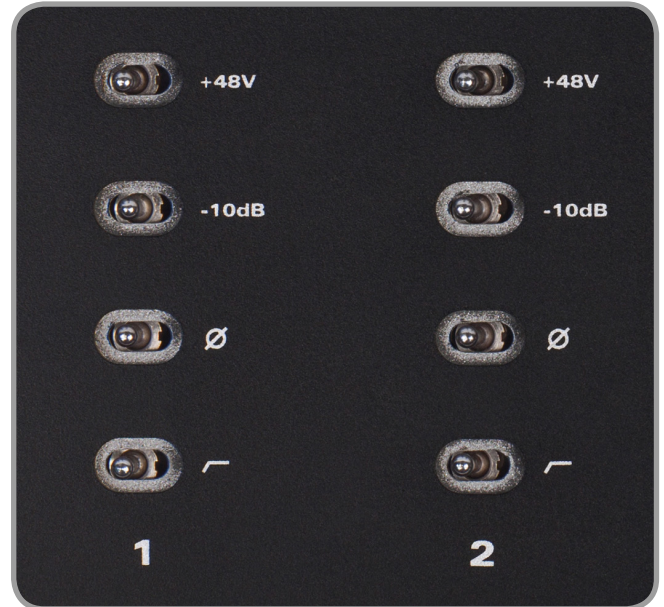

Neutrik™ XLR/TRS Jack combi-connectors provide microphone and line inputs. The line inputs are padded through the microphone preamplifiers and have access to the pad, polarity reverse & HPF functions, therefore accommodating a huge range of input levels with freedom from overload.



Instrument Input

iD22 employs a discrete class-a JFET instrument (D.I) input on channel two.

Plugging in a TS (tip-sleeve unbalanced) jack will override the mic signal and turn channel two into a fully fledged, fantastic sounding instrument input with access to a -10 dB pad (for hot output instruments such as active basses, drum machines and synthesizers), polarity reverse (useful for phase alignment between a mic and D.I) and the HPF (useful for taming unruly low frequency content).



Balanced Inserts Send & Return

Once signal has passed through the microphone preamplifier and input conditioning stage - it is provided at a balanced insert send jack.

Both input channels feature impedance balanced insert sends and electronically balanced insert returns before the AD converter.

These console-style insert points make it very easy to add your favourite processing prior to conversion - setting iD22 apart from much of the competition.

Insert your favourite compression and EQ here to build vocal chains that rival the very best. Rest assured the mic pre in iD22 will stand up to many outboard units costing several times more than the entire unit!

Insert Normalising

Insert send & return jacks use normalising connectors and therefore do not need to be patched when not in use.



Patching Inserts

To incorporate your favourite processing prior to conversion, simply patch the iD22 insert send into your processing chain and take the output of the last device in the chain and patch back into the insert return on iD22.

iD22 Microphone Preamplifier

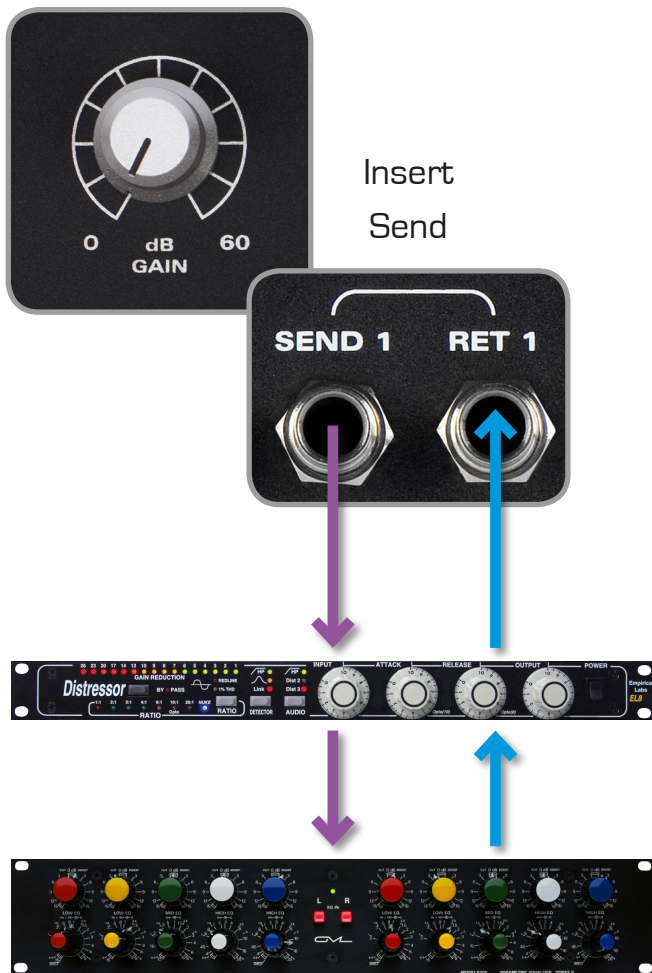

Processing Chain

Direct Access to ADC

The insert return connection on iD22 is a very pure electronically balanced input stage that directly drives the analogue to digital converter stage (ADC).

As such this is a great place to return signals directly into the ADC ensuring minimal signal path colouration.

Calibration Level: 0dBFS = +18dBu

This is a great place to patch the outputs of your existing outboard mic pres or indeed to bypass the iD22 mic pres and use as a very pure unity gain line level ADC input for incorporating hardware inserts or using a mastering style process path.

Great for using DAC outputs 3+4 to drive a hardware mix bus compressor and printing back via the pure signal path of the insert returns.

Insert Returns = Line Level ADC Inputs



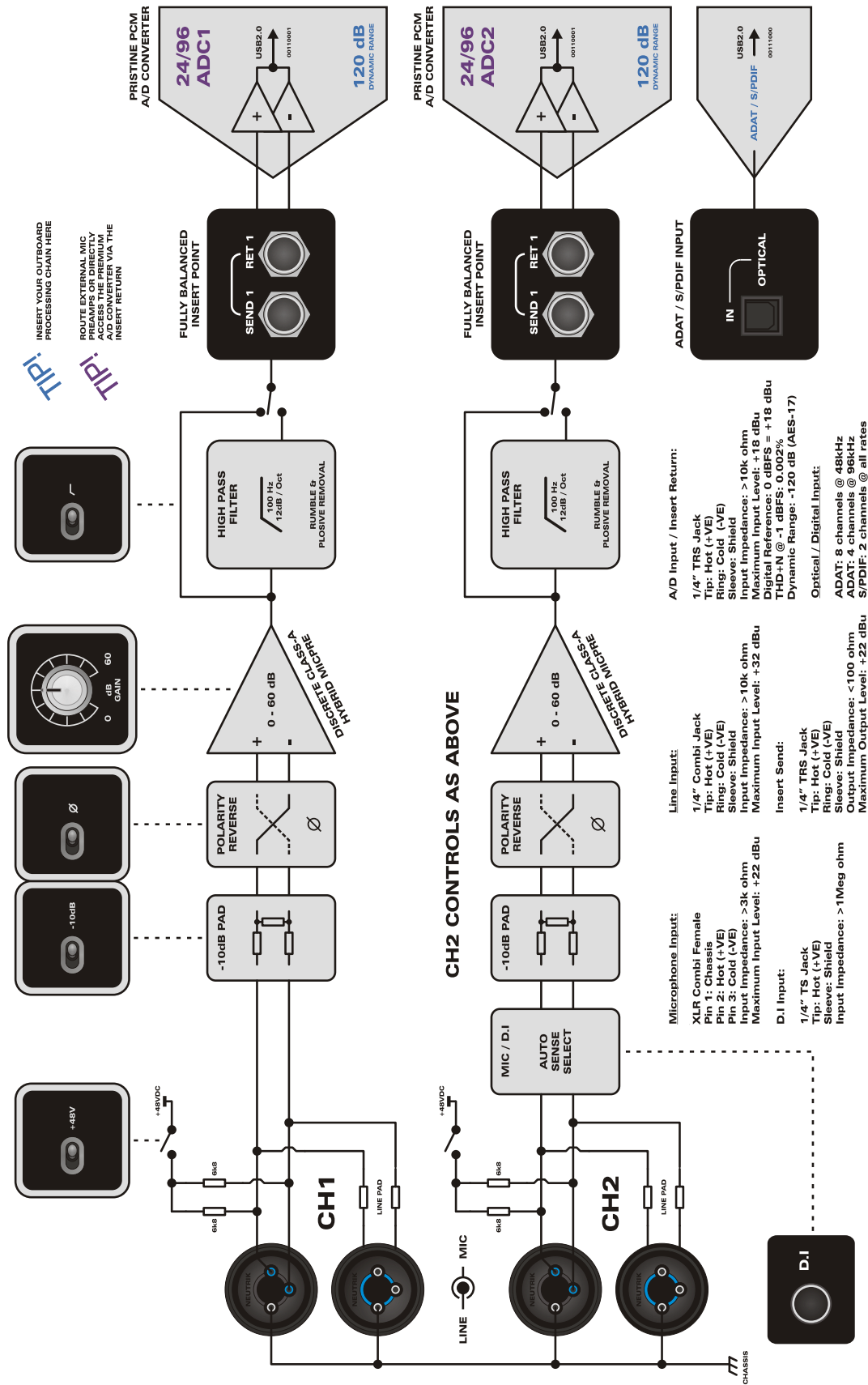

Class-A Mic Preamplifiers, Inserts, A/D Converter & Optical Input Block Diagram

Assignable Line Outputs & DACs

iD22 features four assignable line / DAC outputs. These can be used to create many useful routing options for both tracking and mixing.

Output assigns take place in the iD mixer application System Panel (see page 27 for details accessed in the Master Section).

Here a selection of radio buttons allow outputs to be fed from either the iD DSP mixer main output, the iD mixer cue outputs (A or B), an alternative loudspeaker output or directly from your DAW (bypassing the iD DSP mixer by paralleling the input straight to the DACs).

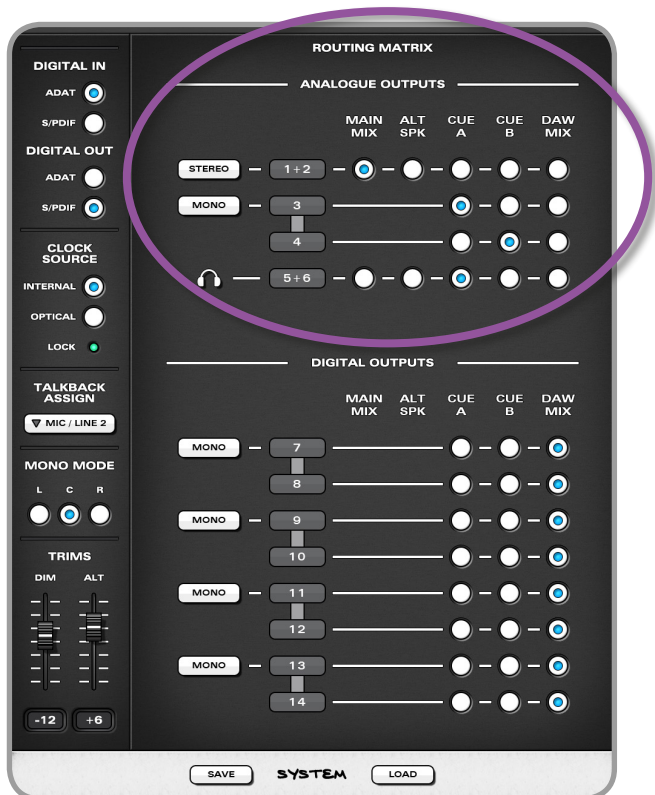

Typical Output Routing

In traditional style tracking situations with separate engineer and artist(s) mixes, outputs 1+2 would likely be set to Main Mix to provide output to control room speakers.

Outputs 3+4 can be set to feed a cue mix (from Cue A or B) to external headphone amplifiers in either ganged stereo or dual mono.

iD22's built in headphone output (5+6) could be used as a 2nd reference for the engineer (set to monitor the Main Mix) or as an alternative and independent headphone mix for an artist (set to Cue A or B).

If you prefer to balance all headphone mixes from inside your DAW (at low buffer sizes to minimise latency) then selecting DAW Mix for outputs 3+4 and 5+6 would allow your DAW to directly address the DA converters and outputs without passing through the iD DSP mixer (note the mixer is still active).

In traditional mixing situations, outputs 1+2 would be set to monitor the Main Mix (taking advantage of the DSP monitor controller functionality in iD22. Outputs 3+4 can be set-up as an alternative speaker destination (main/mini etc) and headphones (5+6) can also be fed for reference.

DAC & Line Output Routing Ideas

iD22 provides some very flexible output routing and these are best demonstrated in diagram form.

Using iD22 for Monitoring & Tracking:



Using iD22 for Mixing & Alt. Monitoring:



All four line outputs are electronically balanced using the same topology as our famous console, the ASP8024.

Expect plenty of output drive (>18 dBu), good noise rejection and a balanced output impedance of <math><100\Omega</math>.

Using iD22 with Hardware Process Path:

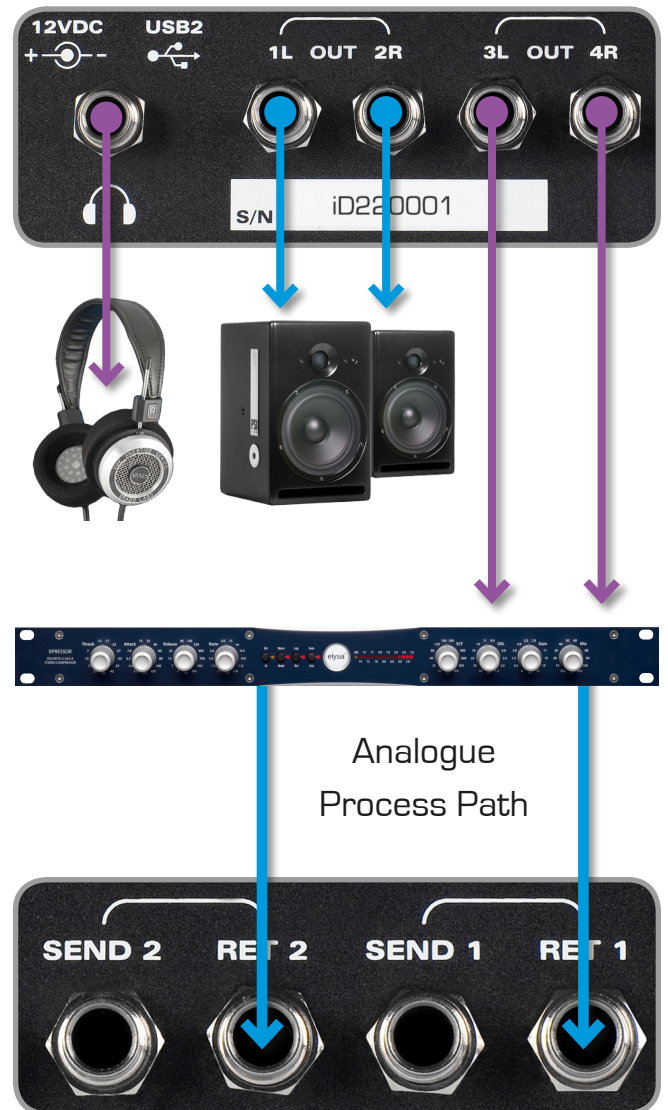

Example Output Routings - iD Mixer

Using iD22 for Monitoring & Tracking:

- Outputs 1+2: Main Mix to C/R
- Output 3: Mono Cue Mix A
- Output 4: Mono Cue Mix B
- Outputs 5+6: Phones Cue Mix A

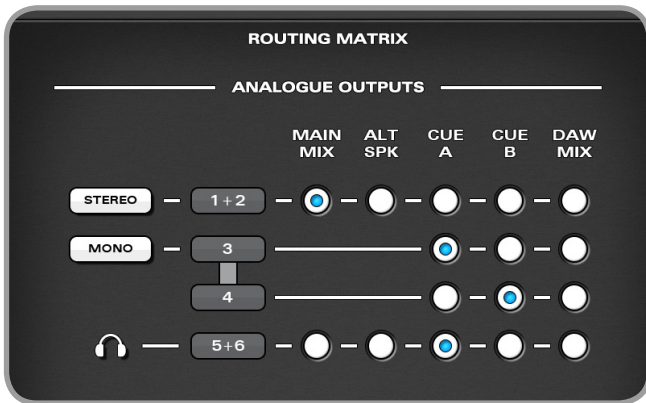

Using iD22 for Mixing & Alt. Monitoring:

- Outputs 1+2: Main Mix to C/R
- Outputs 3+4: Alt. Loudspeaker
- Outputs 5+6: Headphone Reference

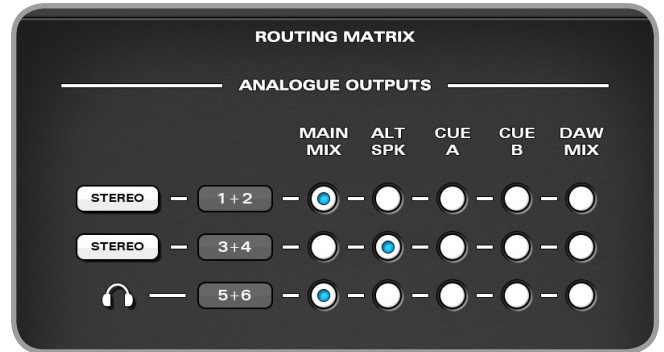

Using iD22 with ITB Headphone Mixes (send DAW headphone mix to iD22 3+4):

- Outputs 1+2: Main Mix to C/R
- Outputs 3+4: DAW Mix (ITB Phones)
- Outputs 5+6: Main Mix (Engineer)

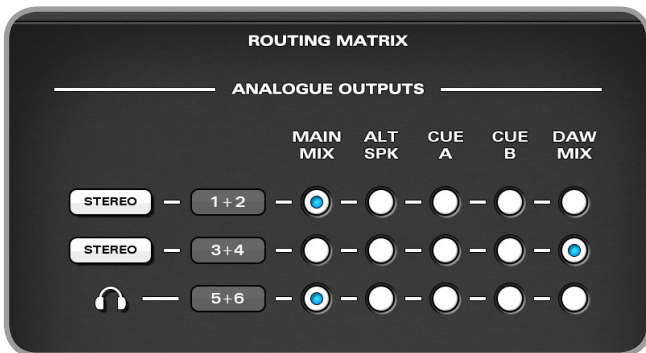

Using iD22 with Hardware Process Path (bypassing iD mixer & monitor controller, using with existing analogue monitor control):

- Outputs 1+2: DAW Mix (Direct)
- Outputs 3+4: DAW Mix (To Outboard)
- Outputs 5+6: Headphone Reference
- Outboard sent back to Insert Returns

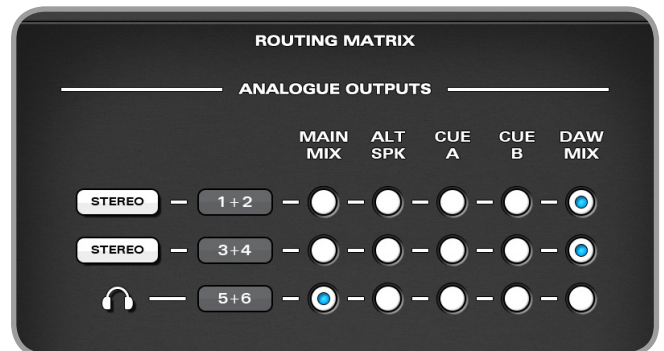

Headphone Output

iD22 features a high current headphone amplifier which is fed by it's own separate DAC. This can be used for reference monitoring, to provide artist headphone mix or to drive a small set of loudspeakers from an unbalanced Y-split cable.

The headphone amplifier can be fed from a number of sources as set in the Routing Matrix found in the System Panel of the iD mixer application (see previous pages or the section found on page 29 for more info).

A front panel potentiometer provides digitally calibrated and perfectly matched stereo volume control over the headphone output.



Digital Inputs / Outputs

To complete the i/o package, iD22 features an optical input and output connection. These can be set to operate as stereo optical S/PDIF or 8-channel ADAT via the System Panel in the iD mixer application. Both formats will operate at up to 96kHz sample rate, with ADAT dropping to 4-channels at rates above 48kHz.

Running in S/PDIF mode, the optical i/o provides the option to integrate an *audient* MiCO™ for 4-channels of *audient* micpre, or an external reverb for monitoring.

Running in ADAT mode, the optical i/o provides a great way to expand to 10-inputs via an *audient* ASP880™ for recording. The ADAT outputs could also be connected to headphone distribution systems such as a Hearback™ HUB or to an 8-channel DAC for summing purposes. We designed iD22 to grow with your needs.

For more information about setting up sample rates and system clocking please refer to pages 27 and 33 onwards.

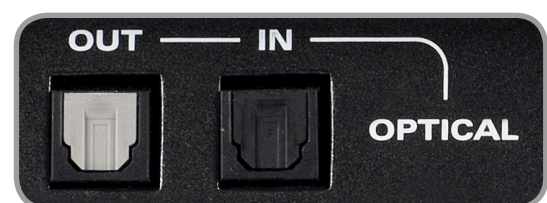

Monitor Control

iD22 provides all of the excellent monitor control functionality as found on one of our consoles.

As such, it is possible to control main and alternative loudspeaker volumes with a perfectly matched stereo volume control on the main unit.

The MONITOR knob is solid aluminium and feels expensive - which is just the way it should be when you will touch it every day.

There is no signal degradation in this volume control and stereo image will not wander about at various listening levels - the image will be rock solid.

Accompanied by this monitor volume knob are permanently assigned hardware DIM & CUT switches.

The level of DIM and ALT. Loudspeaker trim can be adjusted in the iD mixer application [System Panel].

Alongside these functions, three user programmable 'F' keys provide access to several useful monitoring features.

Monitor Control Features

- Volume control (perfectly matched)
- Alt. Loudspeaker with programmable level (assignable to an 'F' key)
- DIM with programmable level
- CUT
- Mono Sum (assignable to an 'F' key)
- Polarity reverse (assignable to an 'F' key)
- Talkback (assignable to an 'F' key)

By using polarity reverse and mono sum it is possible to listen in sum or difference [mid or side] modes. This provides an excellent way to check mono compatibility and to also learn spatial tricks from your favourite reference material. Please see this *audient* blog for more information on sum & difference monitoring:

<http://blog.audient.com/post/29826572065/sumdifference>



Hardware Metering

4-segment hardware LED metering can be found on the main panel of iD22.

This meter is peak reading and calibrated to the digital recording medium.

iD22 converters use a standard calibration level of 0dBu = -18dBFS, or perhaps more importantly +18 dBu = 0dBFS.

It is suggested that end users observe their DAW metering for recording levels, hence currently the iD22 hardware meters indicate playback level in the main mix bus of the iD mixer application.



Status LED



The status LED indicates connection via USB to your computer. Please see page 7 for more information.

Switch Operation

All hardware push switches (DIM, CUT etc) feature momentary operation if pressed and held or latching operation if pressed and released quickly - very useful!

Kensington Lock

For those of you who work in educational establishments or in situations where your equipment is public facing and subject to possible theft opportunities, we have added a Kensington lock hole to the chassis to enable you to protect your iD22.



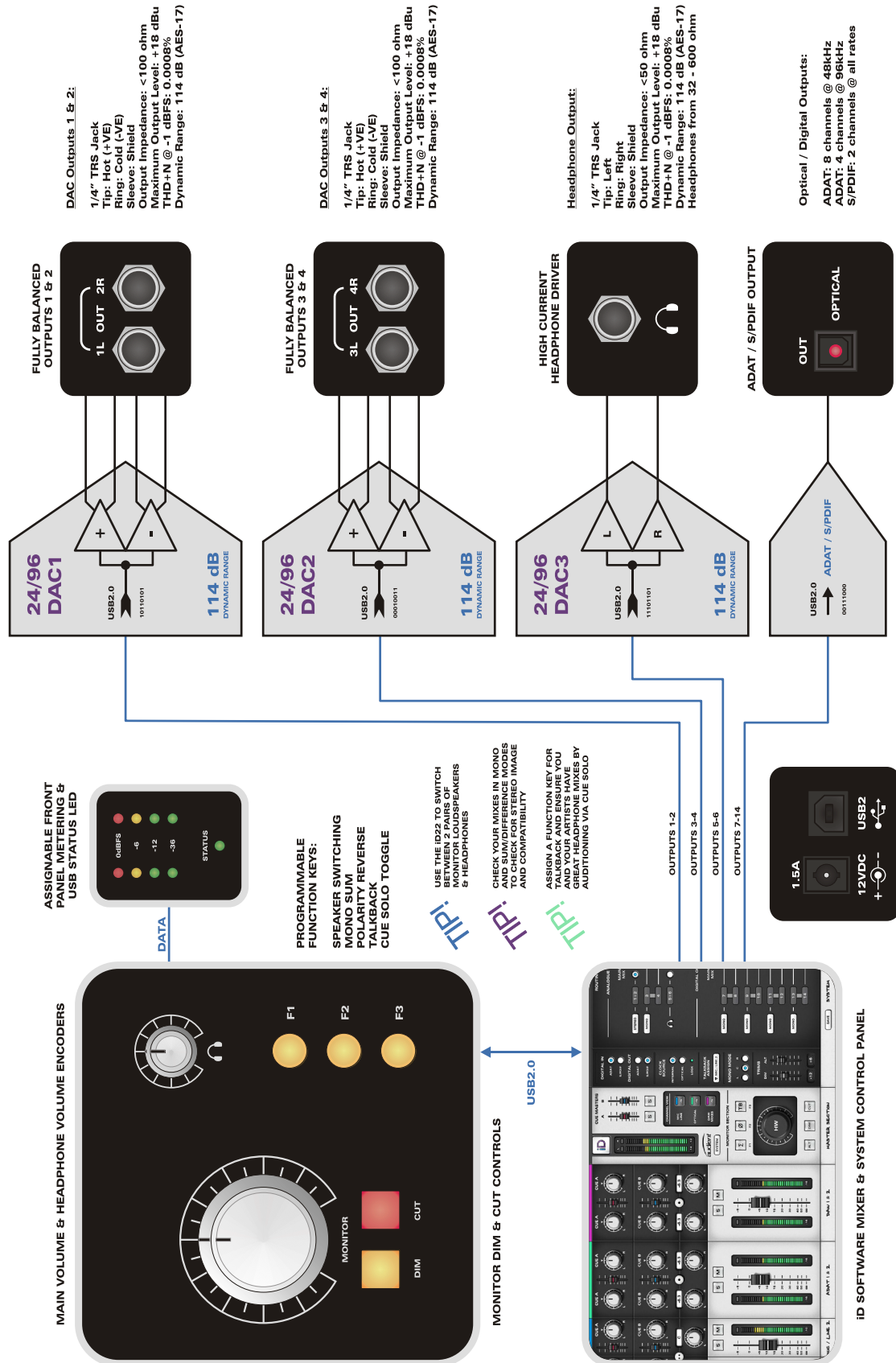

High Performance D/A Converters, High Current Headphone Amplifier & Optical Output Block Diagram

Input Channels - Channel Types

The iD mixer application features three types of input channels, these are colour coded and are as follows:

- Analogue (Inputs 1+2) - **BLUE**
- Digital (S/PDIF or ADAT) - **GREEN**
- DAW Mixes (Playback 1-6) - **PURPLE**

DAW inputs are provided as three stereo pairs and are designed as 'virtual' playback channels from your DAW.

These can be monitored via the onboard DSP mixer, routed to cue mixes or hard assigned to DAC outputs.

Addressing outputs in your DAW will feed signals into these channels. Therefore iD22 can sum all three signals together for monitoring and access to cue mix buses.

Channel Naming Strip

Harking back to our large format console heritage - the iD mixer application allows you to label your channels via the editable marker pen text on console tape!



Analogue input channels are taken directly from the two ADC (insert returns,) signals available here are; microphone, line, D.I (channel two) or unity gain line input at the return jack.

Digital inputs are provided as two channels in S/PDIF mode and eight channels in ADAT mode (four at > 48kHz).

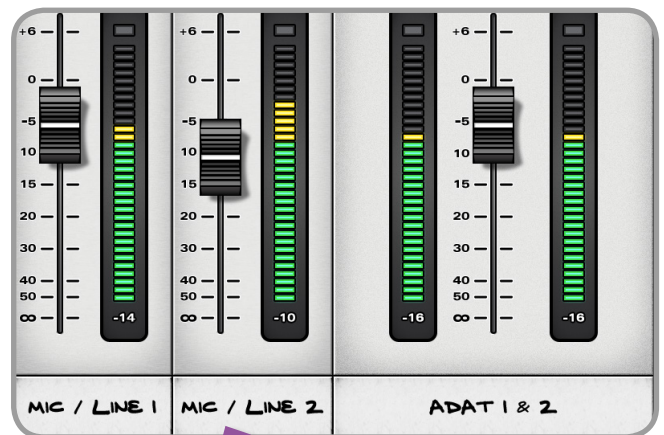

MIC/LINE 1 or **KICK** for example

Channel Strip Controls



Cue A Send Controls
Level (0 dB to off)
Pan (if using stereo cue)

Alt + click to zero

Cue B Send Controls
Level (0 dB to off)
Pan (if using stereo cue)

Alt + click to zero

Parameter Info Box
Normally displays main channel pan value but if you hover the mouse over any control - it will display that parameter's value so you can see what's what

Channel Solo & Cut
Latching operation

Command (⌘) + click (Ctrl + click on Windows) on a solo switch, while on an un-solo'd channel will override any previously solo'd channel

Command (⌘) + click (Ctrl + click on Windows) on an already activated solo switch will clear all solo'd channels

Channel Fader
+6dB to off
Alt + click to zero

Channel Meter
66dB Range
Separate Peak Hold Indicator
Click on peak indicator to clear
Alt + click to clear all

Channel Tape Label
EDITABLE - 8 characters

Stereo Linking

All channels can be linked or un-linked for stereo or mono operation. Level controls are ganged in stereo operation but stereo panoramic positioning control remains individual for left and right channels.

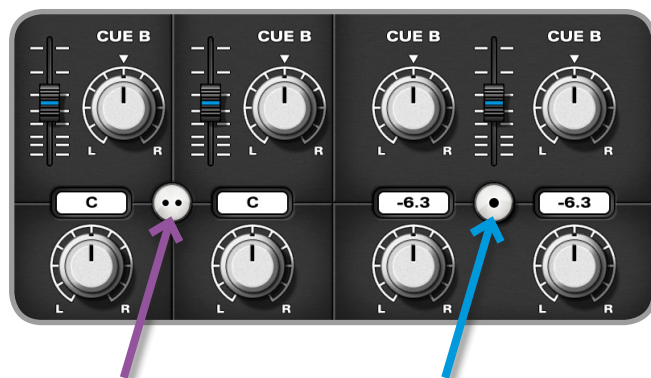

- Unlinked
- Individual Level
- Individual Pan
- Linked
- Ganged Level
- Individual Pan

Useful Functionality

Every active control (buttons, pots or faders) in the iD mixer application feature colour coded mouse over indicators to help you quickly navigate and make adjustments.

All controls are also scroll-wheel enabled in the iD mixer application.



Master Section

Main Meters
66 dB Range

These meters indicate the output levels of the DSP mix bus within iD22. They are mirrored by the 4-segment hardware LED meters on the main unit

1dB steps from 0 to -6dBFS
2dB steps from -8 to -56dBFS

Separate Peak Hold Indicator
Click on peak indicator to clear
Alt + click peak to clear

System Panel Button
Opens the iD22 set-up and routing matrix panel (see page 29)

Mono Sum Button
Monitor the output of the iD22 DSP mixer summed to mono

Assign to 'F' key > right click & select F1, F2 or F3

Polarity Reverse Button
Invert polarity of one side of the stereo monitor output for stereo difference checks

Assign to 'F' key > right click & select F1, F2 or F3

Hardware Volume Control Only

Alt. Loudspeaker Button
Switch to alternative monitors if set-up in system panel matrix as out 3+4

Assign to 'F' key > right click & select F1, F2 or F3

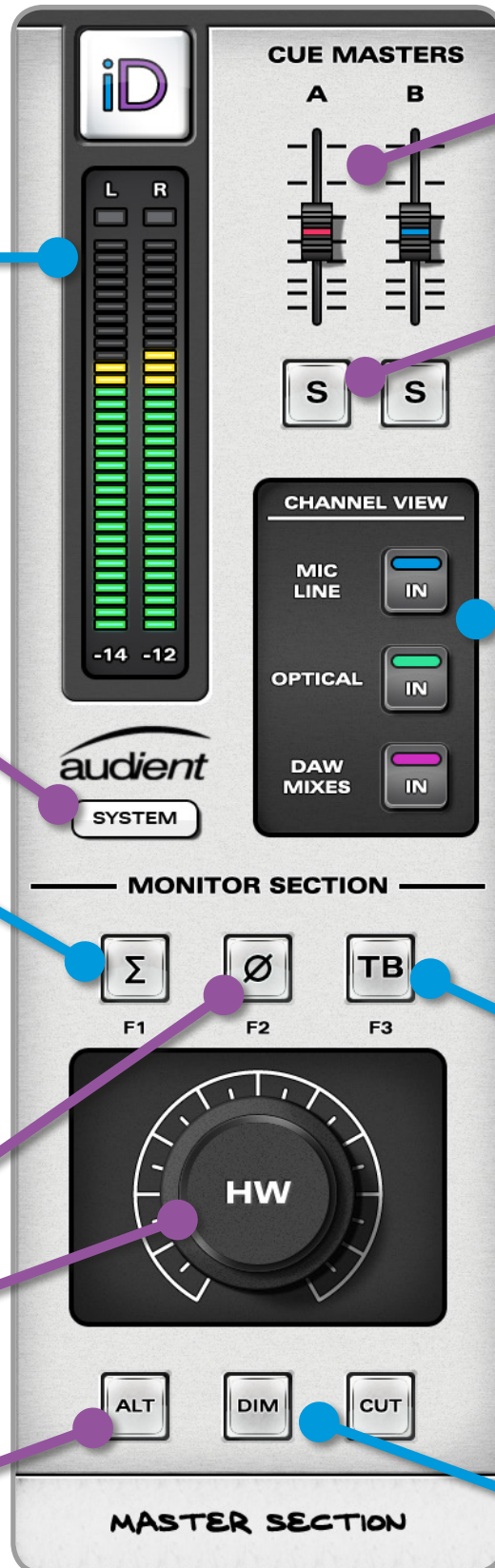

Cue Masters
Level [0 dB to off]
Controls output level of all summed cue sends

Alt + click to zero

Cue Master Solos
Use these cue solos to audition artist mixes quickly. They operate in an interlocked fashion so only one can be solo'd at a time

Channel View Buttons
Customise your mixer layout by including only the channels you are using

Not using the digital i/o?
Hide it

Mixing / listening back and want to hide most of the GUI? You can

Show / hide when required

Talkback Button
Operating the talkback switch routes whichever input has been selected as talkback (in system panel) to both cue A & B (level set by talkback channel cue send levels) and to your DAW. This way talkback can be sent directly to artists or via the DAW to a record enabled or input monitored track (SLATE mode)

Monitor Dim & Cut Buttons
DIM auto-triggered by talkback. Level programmed in system panel. Permanently controlled by hardware switches

Channel View Settings

When tracking (without using a digitally expanded iD22) it is most likely that the following channel view (Analogue + DAW) would be the most useful, enabling you to see mic/line inputs and DAW returns:



Volume Control

The output of the iD DSP mix bus is sent to whichever output is set-up as Main Mix in the Routing Matrix. This is your monitor destination and should be connected to your main studio loudspeakers.

To control the monitor volume of this output, use the hardware knob on the main unit.



For simple monitoring / listening or ITB mixing it may be cleaner to view just the master section.



Or when fully expanded via ADAT with something like an ASP880, you can view all channels (after 10 mono slots, a scroll bar appears).

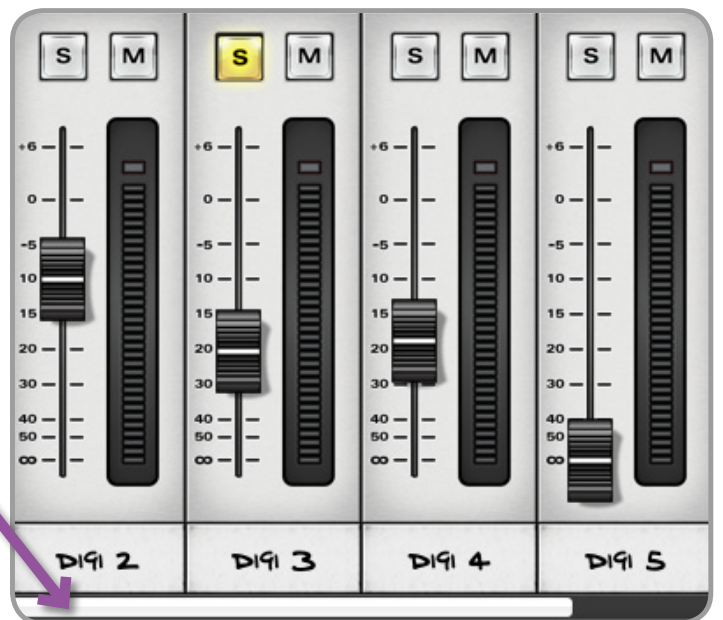

View Mode Shortcuts:
See page 32

Programming 'F' Keys (Monitor Control Functionality)

There are several functions that can be assigned to the hardware 'F' keys.

Σ Mono Sum

In order to check your mix for mono compatibility (still important for DAB radio and laptop / ipad users) either use the Mono Sum button in the iD software or assign it to an 'F' key by right clicking.

\emptyset Polarity Reverse

By pressing the polarity reverse button, the left channel of the stereo mix is inverted. When combining this with the right channel using the mono sum feature in conjunction with the polarity reverse function - a L-R sum is created instead of an L+R sum. This will cancel the centre (sum) of the stereo signal and leave behind the difference signal (L-R). Monitoring this provides a great way to listen to stereo content such as reverbs and also pick up tricks from your favourite mix engineers. It is a very useful and different perspective of the mix balance.

Talkback - see page 28 for more information.



ALT Alternative Loudspeaker

To set-up an alternative loudspeaker for greater monitoring flexibility - a pair of outputs must be assigned as a source to the alternative pair in the System Panel.

These outputs can be digital via S/PDIF or ADAT or indeed analogue via DAC3+4 or DAC5+6.

ALT can be used to turn on headphones if DAC5+6 is selected as the headphone source, alternatively you can feed loudspeakers with DSP control and digital inputs via optical S/PDIF.

However in most standard set-ups, DAC3+4 would be the most likely source.

System Panel

To open the system panel, press the SYSTEM button found in the master section or use Command (⌘) + 4 in OSX, or Ctrl + 4 in Windows.

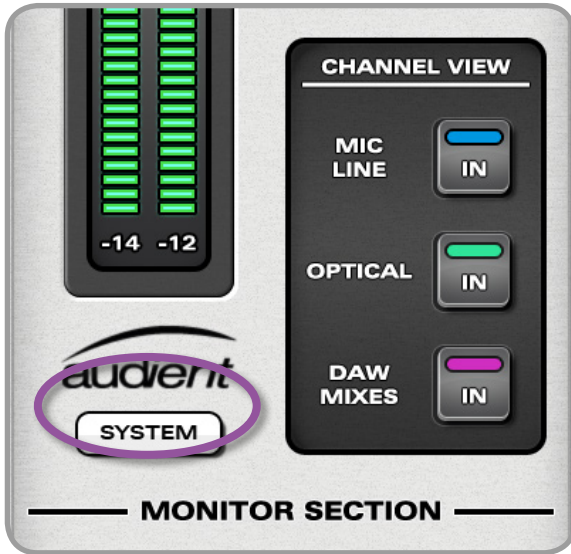

The full system panel contains two sections:

- Setup Strip
- Routing Matrix

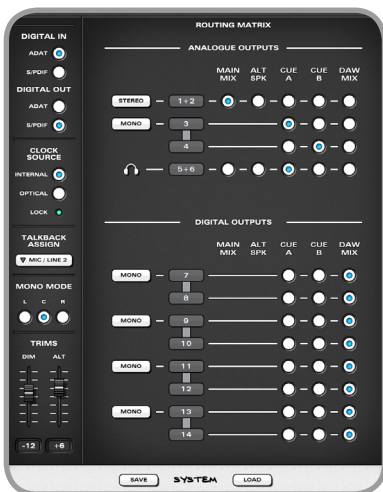

Setup Strip

Digital Input Format
Select 8-ch ADAT or 2-ch S/PDIF input modes for the optical input here.
ADAT 8-ch 44.1 - 48kHz, 4-ch 88.2kHz - 96kHz.
S/PDIF 2-ch all rates

Digital Output Format
Select 8-ch ADAT or 2-ch S/PDIF input modes for the optical output here.
ADAT 8-ch 44.1 - 48kHz, 4-ch 88.2kHz - 96kHz.
S/PDIF 2-ch all rates

Clock Source
Select internal or optical input as the clock source. Ensure all sample rates match your DAW session and computer settings

Lock LED
Indicates a valid external clock source. Red indicator means you have a clocking issue and should check source device

Talkback Assign
Select any available iD22 input (analogue or digital) to be the source for talkback as routed to cues. Mixer channel becomes talkback with no feedback possibility

Mono Mode
Set whether sum-to-mono creates a mono sum in one loudspeaker (one acoustic source) or creates a 'phantom centre' sum (two acoustic sources) - they sound different

DIM & ALT Trims
Set DIM level: 0 to -30 dB
Set ALT loudspeaker level: +/-15 dB



Assigning Talkback

When a channel is assigned as talkback source in the iD mixer application system panel, the equivalent mixer channel strip updates to become a talkback channel.



Channels will be presented in the talkback assign menu as per their labelling in the mixer scribble [console tape] strip. As such they are easy to identify.

No talkback microphone has been included within iD22 as these small electret contact microphone often pickup lots of switch press and handling noise. For many who record vocalists, one input for the artist will be enough so we suggest using a talkback microphone in Input 2, however any of the digital inputs could also be used.

Gooseneck Microphone Use

If recording a vocalist or drummer (with ASP880 expansion) one microphone channel on the iD22 provides the perfect place to use a gooseneck talkback microphone to facilitate desktop communication & monitor control.



Talkback Channel Strip

When an assigned channel converts to talkback operation, cue A & B send level and pan remain, allowing you to route talkback signal to artists via the cue mixes. A channel info box shows adjusted parameter values and a routing box shows which active channel is set as talkback.

A secondary talkback button is located on the talkback channel which can be used to trigger talkback whilst setting up the software mixer. You can assign the talkback switch to an 'F' key in the master section.



Output Routing Matrix

The routing matrix allows you to patch the following iD DSP mixer outputs to the physical DAC outputs (1-6) or the optical digital outputs (1-8 in ADAT mode or 1-2 in S/PDIF mode).

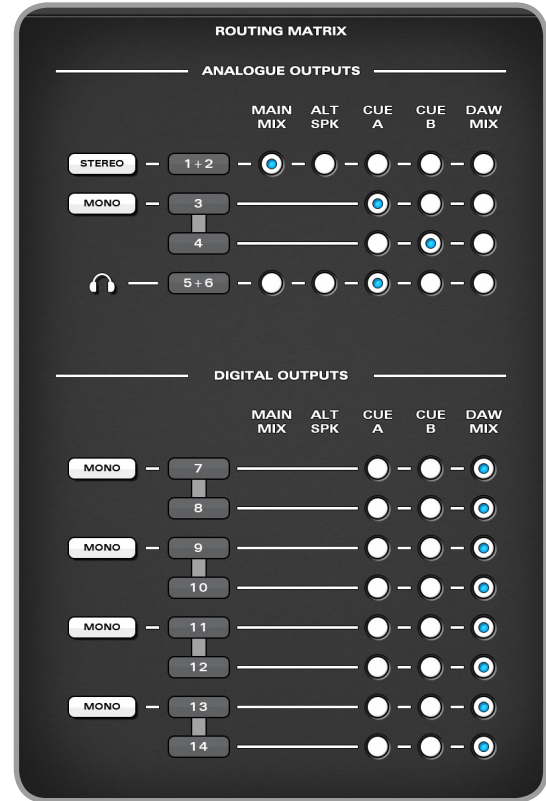
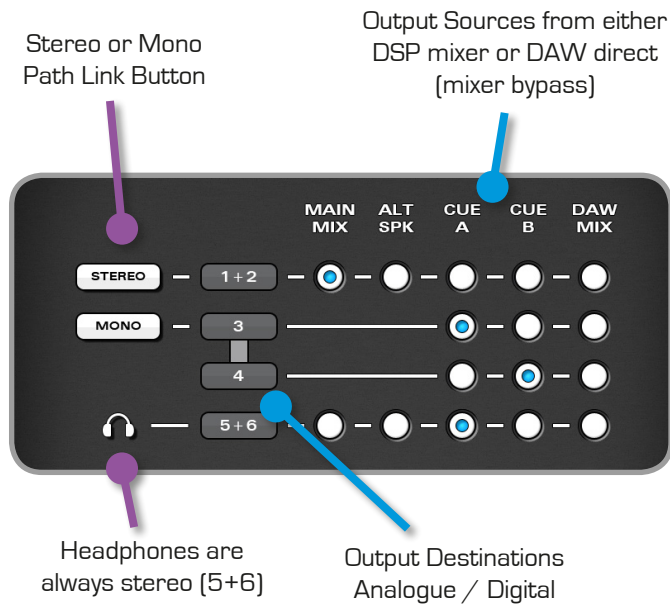

[cue masters are mono summed prior to routing to the DAC outputs]. This would be used to feed an external headphone amplifier to provide two mono artist mixes.

In the above example, DAC outputs 1+2 are setup as a stereo pair fed from the iD DSP mixer main output. This is the default main monitor path and would feed your loudspeakers. The iD mixer main output passes through all monitor control functionality (mono sum, polarity reverse, dim, cut and monitor volume).

DAC outputs 3+4 are set as two mono paths and fed individually by mono Cue A and B mixes. In this scenario note that cue pans controls have no effect

Naturally a stereo cue mix could be created by clicking on the stereo/mono path button and selecting Cue A or B as a source.

Note the flexibility here, as a stereo Cue A mix is feeding the iD22 headphone output (DAC 5+6). Alternative speakers can also be set-up here [typically DAC 3+4].

By selecting DAW Mix the iD DSP mixer is bypassed and signals are effectively 'hard-wired' from DAW to DAC.

Saving & Loading Mixer Presets

Mixer presets can be saved and loaded in two ways:

- Using the buttons at the bottom of the system panel
- Using standard keyboard shortcuts
- Save: Command (⌘) + S
Ctrl + S (Windows)
- Load: Command (⌘) + O
Ctrl + O (Windows)

Saving a Mixer Configuration

Presets can be named when saving from within the system panel, just double click the name box to add.



For information on where preset files are automatically saved, please visit our help desk.

By using the browse button you can save preset files to any folder you desire - allowing you to contain them within your DAW session folder for example (making recall easier).

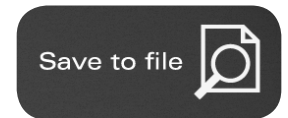

Loading a Mixer Configuration

Loading a preset is very simple, just click on the load button in the System Panel and select one of your previously named files, double clicking will also load a preset. To rename a preset, click to highlight and then after a pause, click again to rename. To delete, click to highlight and then click on the X (delete) button at the bottom.

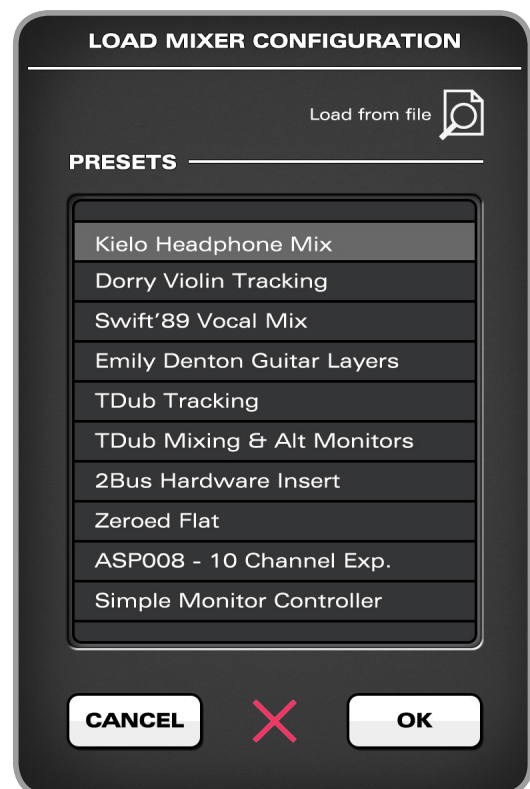

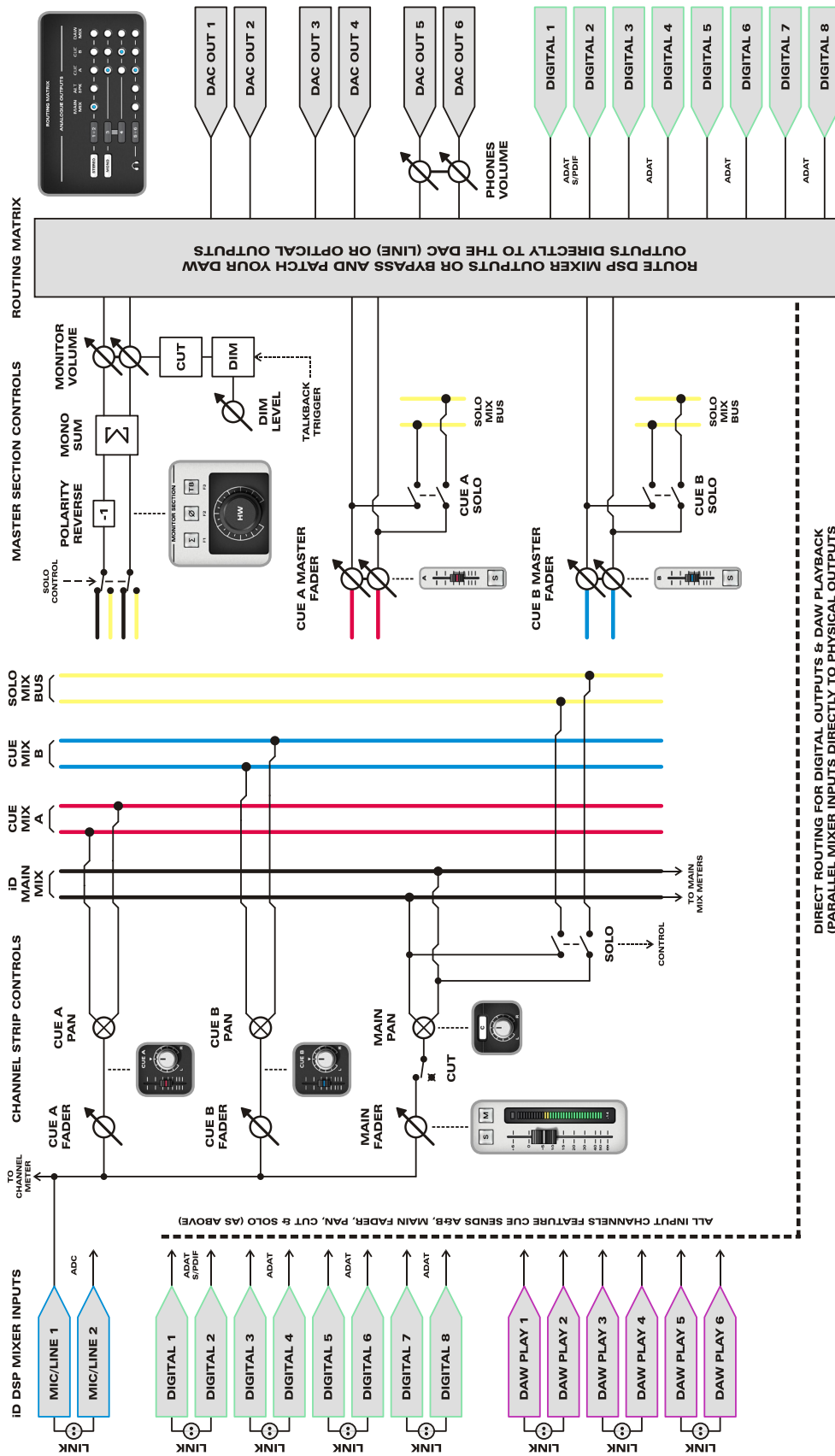

iD22 ONBOARD DSP MIXER APPLICATION BLOCK DIAGRAM

Keyboard Shortcut Index

To allow you to find all shortcuts for the mixer application in one place without having to go through each page of this manual please refer to this table:

Location	Mac	Windows	Description
Faders	Alt (⌘) + Click	Alt + Click	Resets fader to unity gain (0 dB)
Pans	Alt (⌘) + Click	Alt + Click	Resets pan pots to central position
Solos	Cmd (⌘) + Click	Ctrl + Click	Clears all solos if clicking on a solo'd channel Overrides all other solos (for solo exclusive) if clicking on an unsolo'd channel
Meters	Alt (⌘) + Click	Alt + Click	Clicking on peak hold indicator will clear all clip indicators
System Panel	Cmd (⌘) + S	Ctrl + S	Save mixer configuration
	Cmd (⌘) + O	Ctrl + O	Load mixer configuration
View Modes	Cmd (⌘) + 1	Ctrl + 1	View Mic/Line Inputs
	Cmd (⌘) + 2	Ctrl + 2	View Optical (Digital) Inputs
	Cmd (⌘) + 3	Ctrl + 3	View DAW Mix Inputs
	Cmd (⌘) + 4	Ctrl + 4	View System Panel

Please check the iD22 page online at www.audient.com/iD22 for the latest mixer application updates.

More shortcuts may be added without notification.

Operation with Pro Tools

Once iD22 has been successfully installed following the steps detailed on page 6 of this manual, launch Pro Tools and ensure that a new session is created at the desired sample rate (if clocking internally) or at the rate of the clock source (if clocking externally).

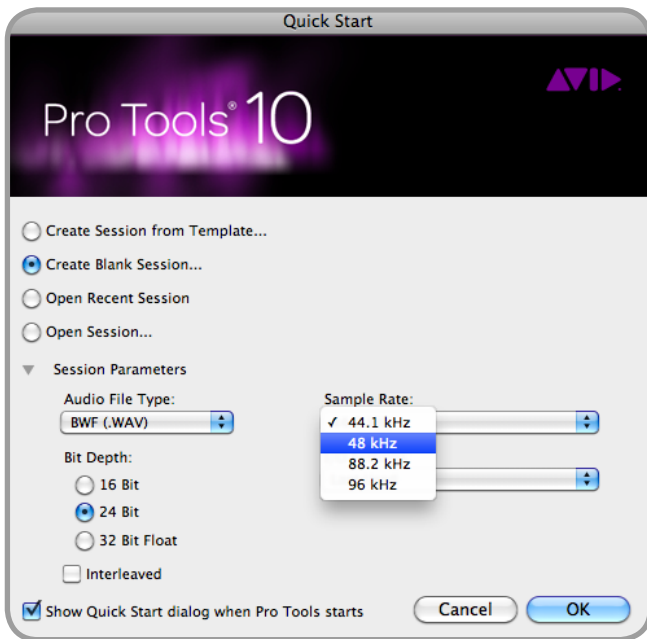

Playback Engine

Go to **Setup > Playback Engine...** and ensure that iD22 is set as the active playback device. Appropriate buffer sizes can also be set here. Please bear in mind that Pro Tools will reboot if the playback device is changed.

For more Pro Tools information consult your Avid user manuals & documentation.

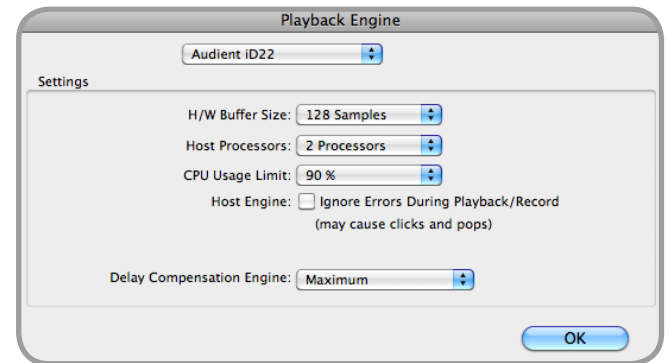

Go to **Setup > I/O...** to label your inputs and outputs and ensure that iD22 is correctly reporting 10-inputs and 14-outputs to and from Pro Tools. Note that analogue outputs 1-6 are in fact the DAW virtual playback channels in the iD DSP mixer and can either be routed through the iD mixer or hard-wired directly from Pro Tools to the DAC stages.

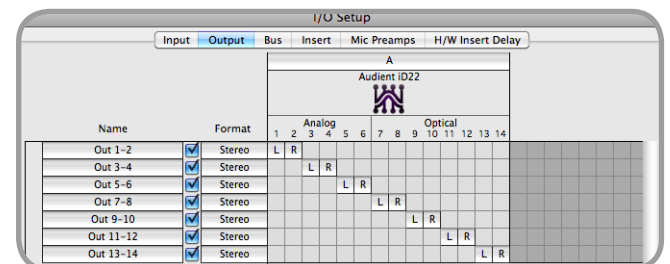
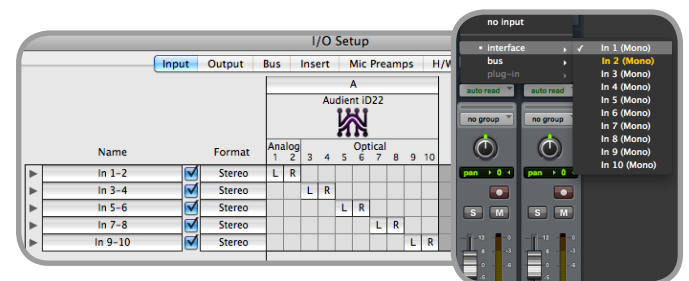

Operation with Logic Pro

Once iD22 has been successfully installed following the steps detailed on page 6 of this manual, launch Logic Pro and check the following:

Logic Pro > Preferences > Audio

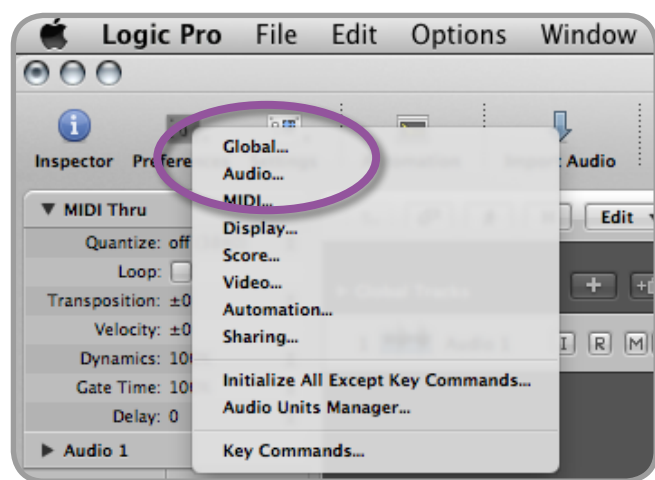

Ensure that iD22 is selected as the active audio device and here you can set buffer sizes to affect system latency. If you are experiencing issues with playback stability and CPU loading, try increasing the buffer size to > 256 samples.

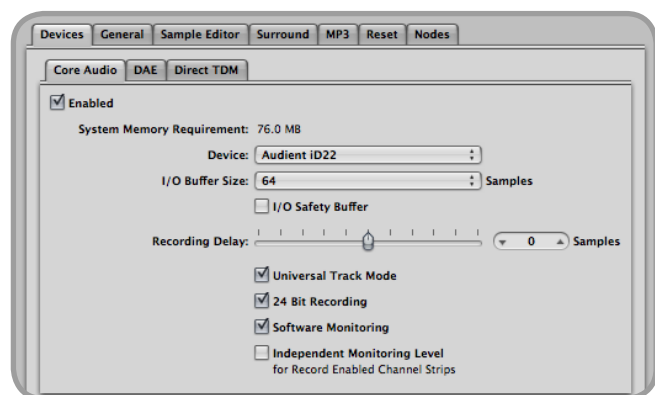

If you are using iD22's onboard DSP mixer to monitor input signals while recording, be sure to disable Logic's software monitoring to avoid phasing as the same source will be heard twice with a short delay between the low latency DSP signal and the delayed software monitoring signal.

Assigning I/O



All of iD22's input and output channels will be available to Logic for routing. There are a total of 10-inputs and 14-outputs reported from the driver.

You can rename input and output channels to whatever you wish using the I/O label function. This is a great way to keep things organised.

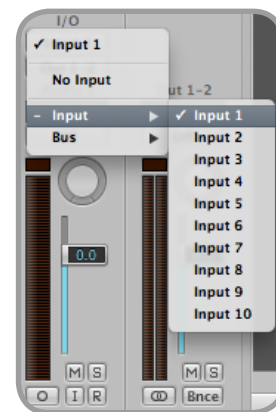

Options > Audio > I/O Labels

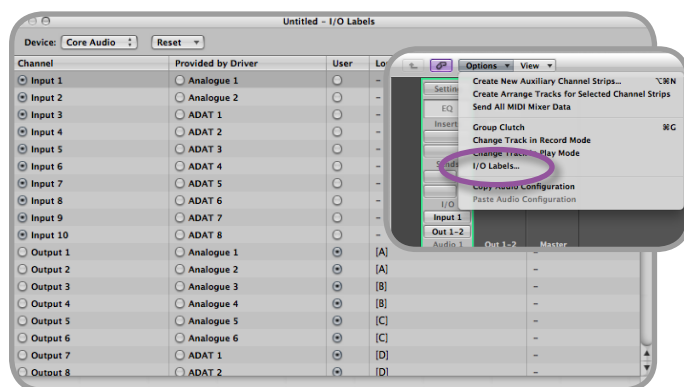

Operation with Logic Pro

If you are using an external clock source (ADAT or S/PDIF) to clock iD22, please ensure that Logic Pro is set to the same sample rate when recording and playing back in a session, otherwise things may sound a bit sharp or flat!

Settings > Audio > Sample Rate



If you are using internal clock on iD22, setting the sample rate via Logic Pro will update the iD22 sample rate to follow your session.

There may be a slight pause as the system re-clocks. This is normal.

This can be verified in [Audio MIDI Setup](#).

Macintosh HD > Applications > Utilities

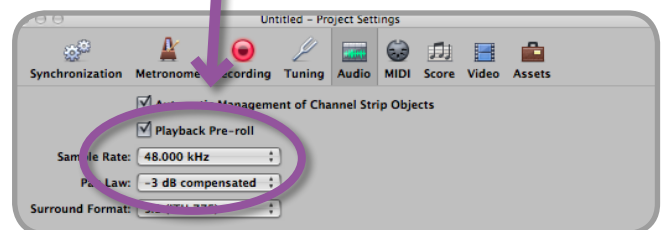
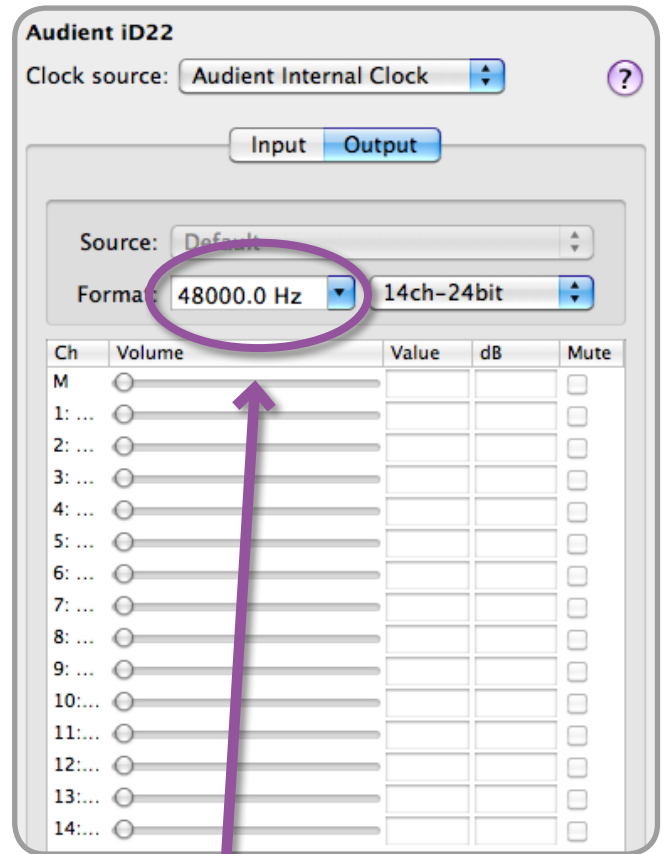

For more Logic Pro information please consult your Apple user manuals & documentation.

Operation with Cubase / Nuendo

Once iD22 has been successfully installed following the steps detailed on page 6 of this manual, launch Cubase or Nuendo and head straight for the Devices menu:

Devices > Device Setup...

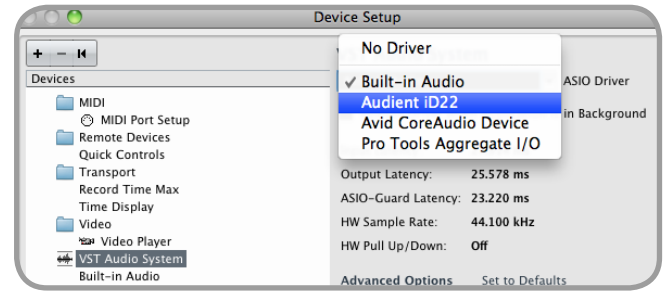

Select Audient iD22 in the menu to ensure that Cubase / Nuendo addresses the iD22 device driver. You will be asked if this is OK, select 'switch'.

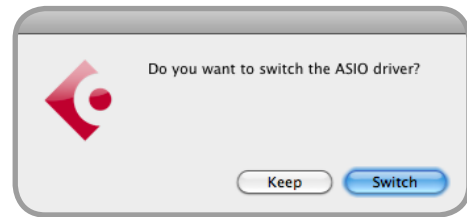

Select Audient iD22 in the devices menu...

Here you will see the main iD22 information, where clock sources can be set as well as activating i/o ports. Be sure to click **Externally Clocked** if clocking from another digital device via ADAT / SPDIF.



Select **VST Audio System** in the devices menu.

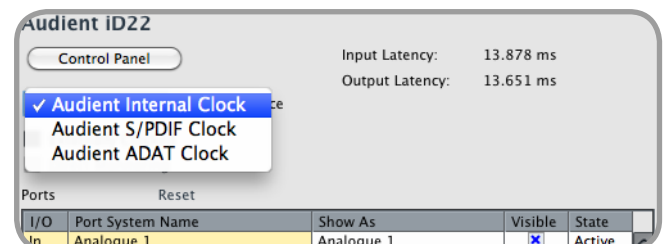
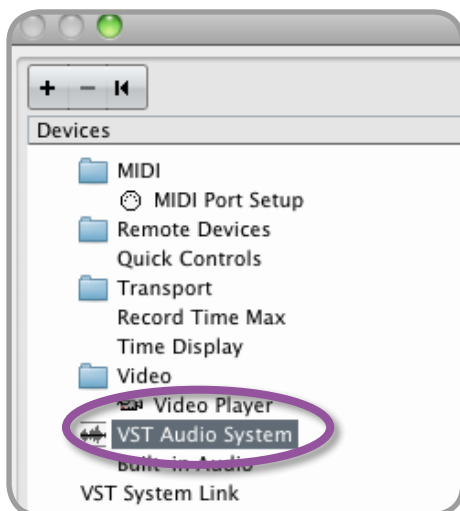

Operation with Cubase / Nuendo

Buffer sizes can be set in the **control panel** within the VST devices display. It would be ideal to keep them quite high to reduce CPU loading if you use the iD22 mixer as the input monitoring device while recording.

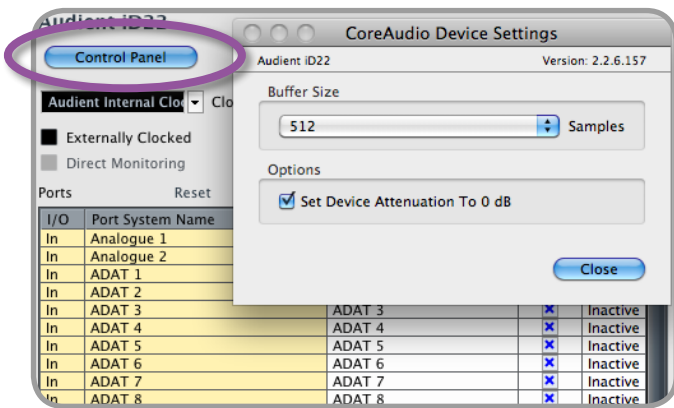

I/O ports can be renamed in the device panel such that they better represent what you connect to them (for example Main Monitors, Alt. Monitors, Hardware Process Loop). This is useful as any names chosen here will be those displayed when assigning i/o on track input/output channel routing.

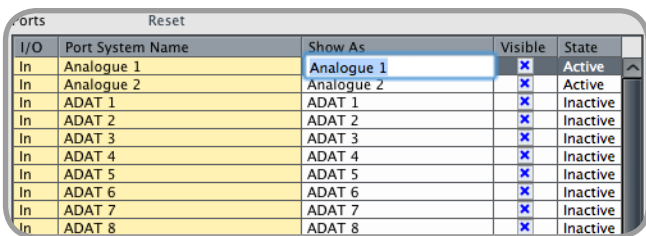

Close the VST device setup panel and navigate to the VST connections panel:

Devices > VST Connections (F4)

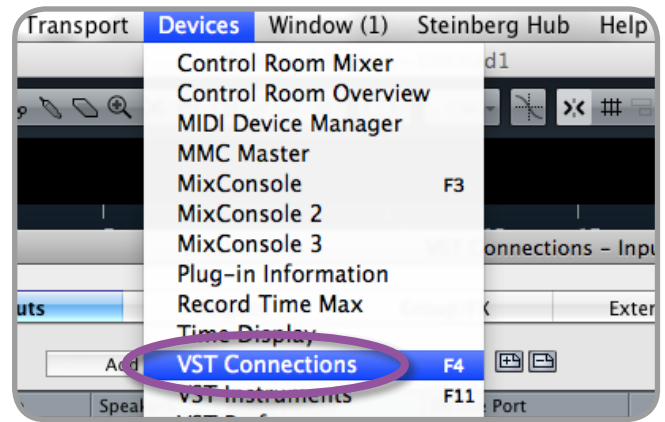

Here you can ensure that all buses have been created in Cubase / Nuendo and therefore all ports are addressable in your session. Add new buses and assign them to the necessary i/o if required.

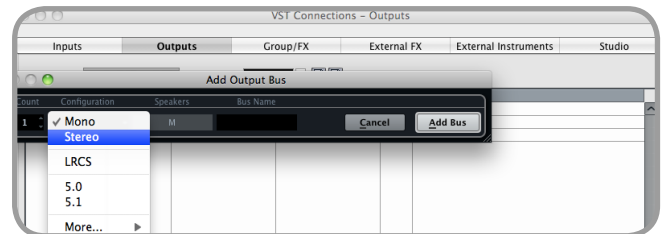
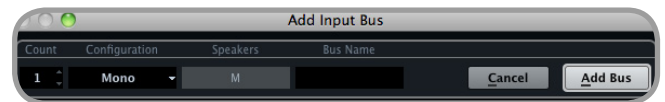
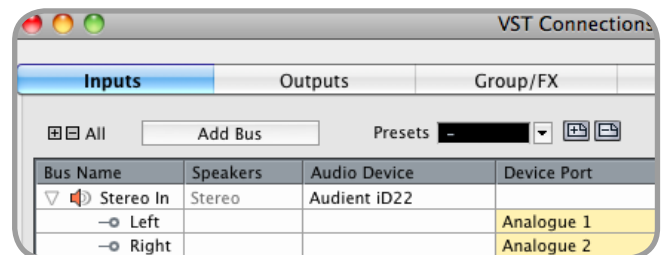

Bus types can be set (mono / stereo) and the VST control room section can also be used. For more information regarding set-up please consult your Steinberg user manuals and documentation.

Operation with Ableton Live

Once iD22 has been successfully installed following the steps detailed on page 6 of this manual, launch Ableton Live and head straight to:

Live > Preferences

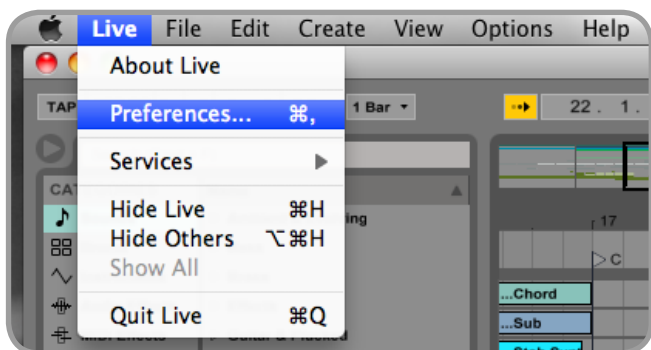

Here navigate to the Audio tab and make sure that iD22 is assigned as the playback device.

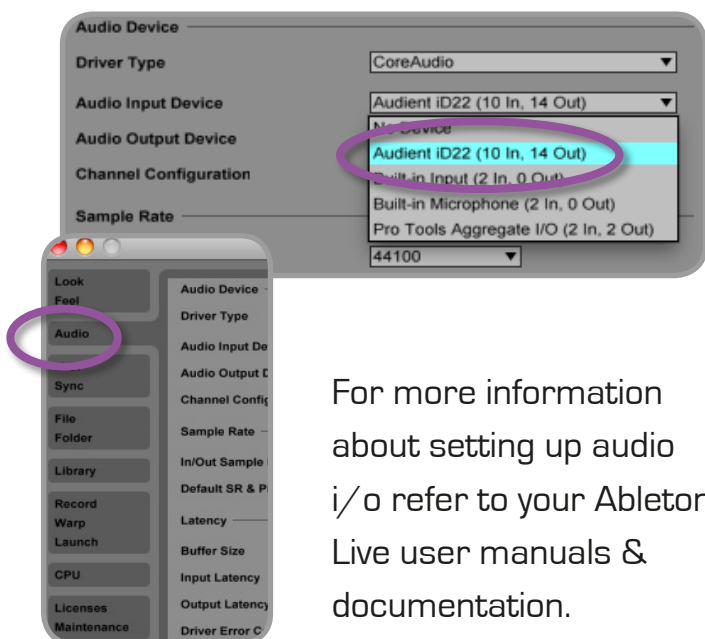

For more information about setting up audio i/o refer to your Ableton Live user manuals & documentation.

In the Live Audio Preference panel you can set an appropriate buffer size (this can be kept high if you are monitoring input signals for recording via the iD22 low latency DSP mixer. Ensure that iD22 reports as a 10-in, 14-out device to Live.

If necessary you can limit the number of i/o channels reported as active inputs (from the driver) in Live by using the [input and output config](#) tabs. This is an excellent feature to help reduce CPU loading if all channels are not required.

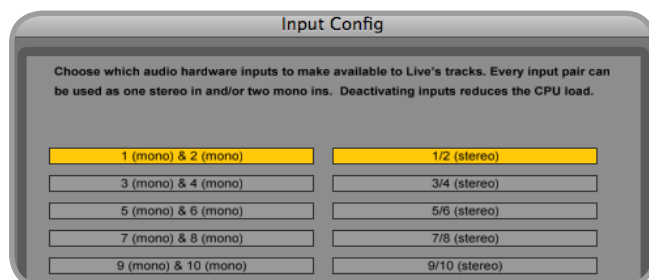

Troubleshooting

- The unit will not power on:

Double check the 12VDC power supply is plugged into iD22 and into an operational mains wall outlet.

To verify the supply is functional, use a multimeter (set to volts DC) and safely measure output DC voltage between centre pin and shield of DC output connector, it should be 12VDC +/-0.5V)

AT NO TIME SHOULD UNQUALIFIED PERSONNEL ATTEMPT TO MEASURE MAINS VOLTAGES OR INTERNAL SWITCHING SUPPLY VOLTAGES

- When I connect to my computer, I cannot play any audio out from iD22:

Firstly double check that the USB cable connecting iD22 to your computer is functional and attached at both ends.

Launch the iD22 mixer application to activate communication between your computer and iD22. This only needs to be done once straight after power up. Once iD22 is set to the operational state you desire, you can quit the iD22 application and it will continue to function as intended.

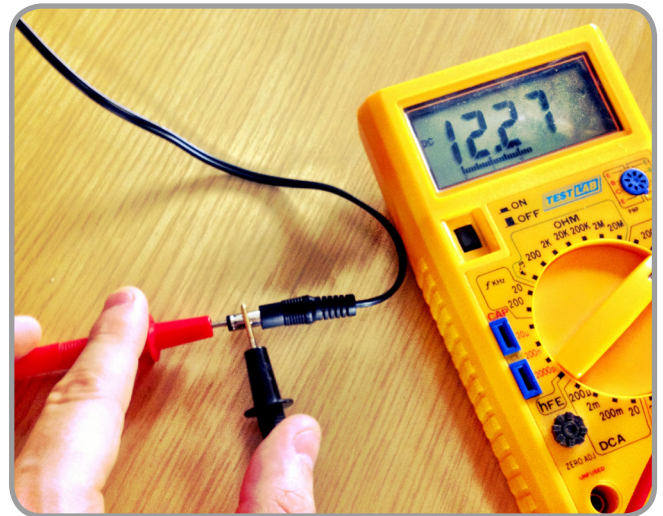

In the software mixer, locate the DAW channels by pressing the DAW view button and increase the level of DAW 1+2 fader.

Double check that iD22 is set as the active playback device in your DAW and computer:

System Preferences > Sound > Output Tab > Audient iD22 (OSX)

Control Panel > Hardware and Sound > Sound > Manage Audio Devices > Audient iD22 (Windows)

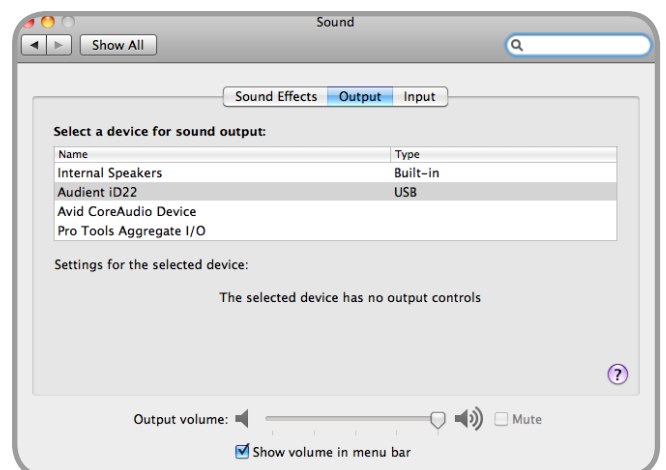

Troubleshooting

- I have clocking issues which include iD22 not locking to external ADAT devices or operating at the incorrect rate compared to my Pro Tools session:

Go to Audio MIDI Setup in OSX, found by navigating to the folder:

Macintosh HD > Applications > Utilities > Audio MIDI Setup

Ensure that Audient iD22 is seen as an audio device ([Window Menu](#), [Show Audio Window](#)).

Double check that an appropriate clock source is selected (Internal for master operation), ADAT or S/PDIF clock for external slave operation. Ensure that you see the correct sample rate displayed in the Format drop-down menu.

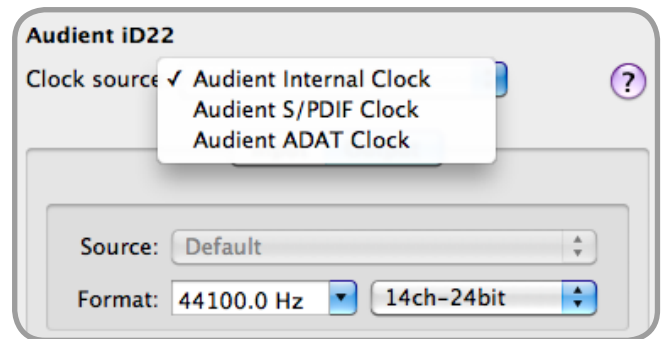

If using Windows, go to the iD icon in the system tray and right click on it. This will bring up some settings including sample rate. Change the sample rate to match that of the external ATAT device and ProTools session.

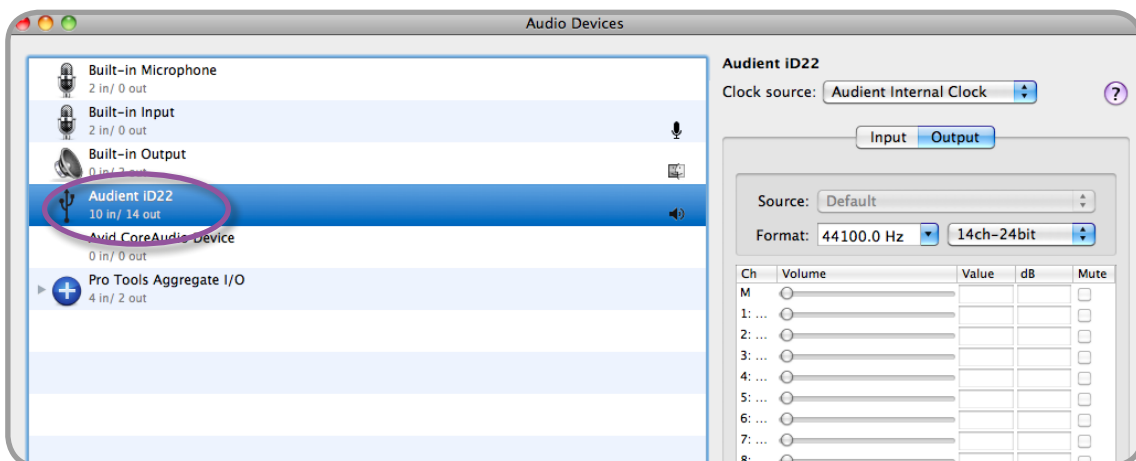

Troubleshooting

- [How do I reset the iD22 mixer application to it's default state?](#)

To reset the mixer application, close the mixer and then navigate to the following folder and delete the state.xml file [it will replenish upon a fresh launch and closure of the application, storing your default setup]:

Macintosh HD > User > Library > Application Support > Audient > iD22 > state.xml

Do not delete the parent folder as this will also contain your iD22 mixer presets.

- [I'm getting random crashes and bugs, how do I make sure I have the latest version of iD firmware/software?](#)

To check for the latest updates to the iD desktop mixer application please visit: www.audient.com/iD22 download the package and install.

To update the iD22 firmware to the latest version please use the Help menu in the application bar and select [Check for Updates](#), refer to page 8 in this user manual for more information regarding firmware update.

FAQs

For more information and bug support, please search our online [Knowledge Base](#) which can be found here:

www.audient.com/support

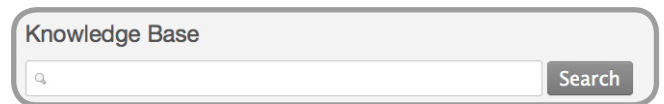

For technical support please create a ticket in our online support system, Zendesk which can also be found in the support section of our website [see link above].

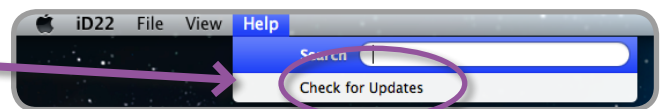
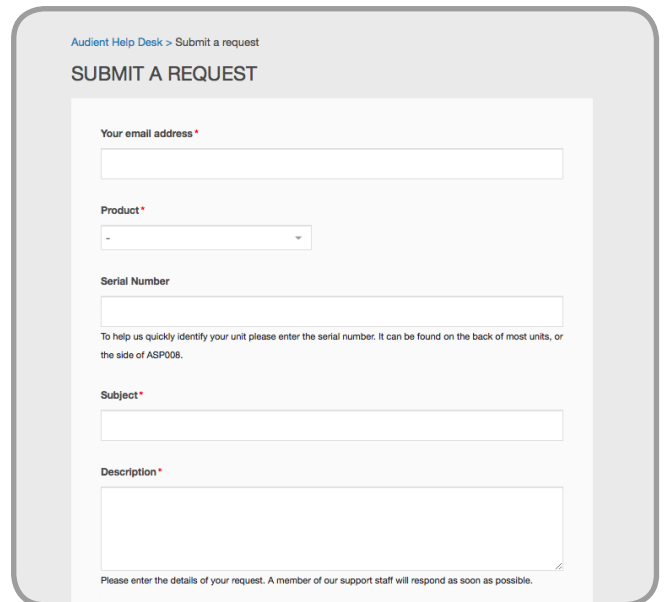



MICROPHONE PREAMPLIFIERS:

(measured to insert send)

MIC GAIN:	-10 to +60 dB [-10dB Pad]
LINE GAIN:	-20 to +40 dB [-10dB Pad]
PHANTOM POWER:	48v +/-4v @ 10mA/Channel
MIC EIN:	<-125dBu
CMRR:	>80dB @ 1kHz
MAXIMUM INPUT LEVEL:	+22dBu [+32dBu with Pad]
INPUT IMPEDANCE (Mic):	>3kΩ Balanced
INPUT IMPEDANCE (Line):	>10kΩ Balanced
FREQUENCY RESPONSE:	+/-0.5dB 10Hz to 100kHz
CROSSTALK:	<90dBu @ 1kHz & 10kHz
THD+N @ 0dBu [1kHz]:	0.0015% [-96dBu]
SNR:	96dB
HPF:	-3dB @ 100Hz, 2nd Order (12dB/Octave)

XLR: Pin 2 (Hot), Pin 3 (Cold) & Pin 1 (Shield)
1/4" JACK: TIP (Hot), RING (Cold) & SLEEVE (Shield)

D.I (Channel 2):

(measured to insert send)

D.I GAIN:	-16 to +54 dB [-10dB Pad]
MAXIMUM INPUT LEVEL:	+16dBu (typical), +22dBu
INPUT IMPEDANCE:	1MegΩ Unbalanced
FREQUENCY RESPONSE:	+/-0.5dB 10Hz to 50kHz
THD+N @ 0dBu [1kHz]:	<0.03% [-70dBu]
SNR:	93dB

1/4" JACK: TIP (Hot) & SLEEVE (Shield)

INSERT SENDS (Mic Pre Out):

MAXIMUM OUTPUT LEVEL:	+22dBu
OUTPUT IMPEDANCE:	<100Ω Balanced

1/4" JACK: TIP (Hot), RING (Cold) & SLEEVE (Shield)

POWER SUPPLY:

12VDC Centre Positive DC Adapter - >1.5Amps
Internally conditioned to provide +48VDC, +/-15VDC & low voltage rails for digital processing core & converters.
iD22 cannot be bus powered for quality reasons.

ADC LINE INPUTS (Insert Returns):

(measured at optical output under AES-17)

MAXIMUM INPUT LEVEL:	+18dBu
DIGITAL REFERENCE LEVEL:	0dBFS = +18dBu
INPUT IMPEDANCE:	>10kΩ Balanced
FREQUENCY RESPONSE:	+/-0.5dB 10Hz to Fs/2
CROSSTALK:	-100dBu @ 1kHz & 10kHz
THD+N @ -1dBFS [1kHz]:	<0.002% [-94dB]
THD+N @ -6dBFS [1kHz]:	<0.0015% [-97dB]
DYNAMIC RANGE:	117dB un-weighted 120dB A-weighted

1/4" JACK: TIP (Hot), RING (Cold) & SLEEVE (Shield)

DAC OUTPUTS (1-4):

(measured from optical input under AES-17)

MAXIMUM OUTPUT LEVEL:	+18dBu
DIGITAL REFERENCE LEVEL:	0dBFS = +18dBu
OUTPUT IMPEDANCE:	<100Ω Balanced
FREQUENCY RESPONSE:	+/-0.5dB 5Hz to Fs/2
CROSSTALK:	-110dBu @ 1kHz & 10kHz
THD+N @ -1dBFS [1kHz]:	<0.0008% [-101dB]
DYNAMIC RANGE:	110dB un-weighted 114dB A-weighted

1/4" JACK: TIP (Hot), RING (Cold) & SLEEVE (Shield)

HEADPHONE OUTPUT (5&6):

(measured from optical input under AES-17)

MAXIMUM OUTPUT LEVEL:	+18dBu
DIGITAL REFERENCE LEVEL:	0dBFS = +18dBu
OUTPUT IMPEDANCE:	<100Ω Balanced
FREQUENCY RESPONSE:	+/-0.5dB 5Hz to Fs/2
CROSSTALK:	-110dBu @ 1kHz & 10kHz
THD+N @ -1dBFS [1kHz]:	<0.0008% [-101dB]
DYNAMIC RANGE:	110dB un-weighted 114dB A-weighted

1/4" JACK: TIP (Hot), RING (Cold) & SLEEVE (Shield)

DIGITAL i/o:

ADAT 8 CHANNELS	44.1 - 48kHz
ADAT 4 CHANNELS	88.2 - 96kHz
STEREO S/PDIF	44.1 - 96kHz

USB2.0 HIGH SPEED:

No. of INPUT CHANNELS 10
(2 Analogue, 8 Digital)

No. of OUTPUT CHANNELS 14
(6 Analogue, 8 Digital)

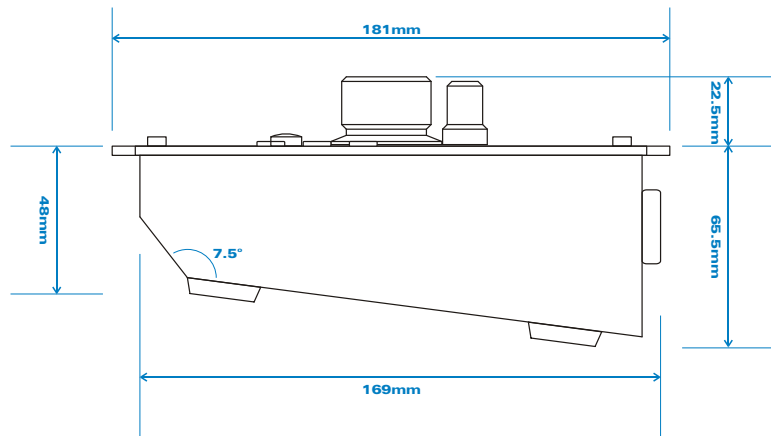
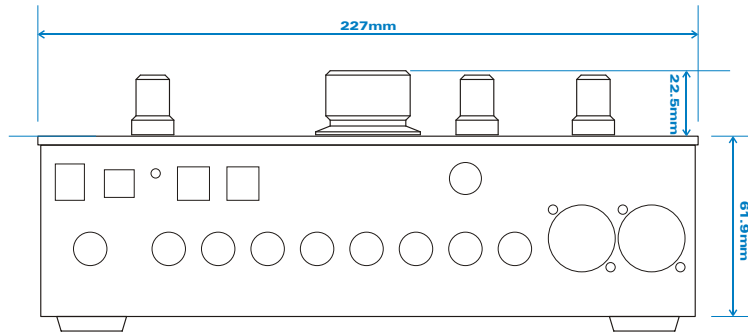
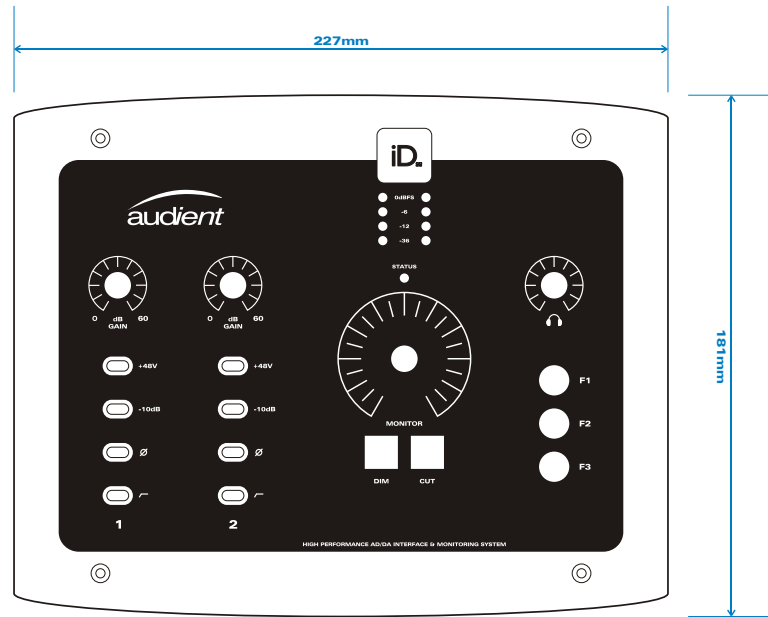

Warranty Statement

Your iD22 comes with a manufacturer's warranty for one year (12 months) from the date of despatch to the end user.

The warranty covers faults due to defective materials used in manufacture and faulty workmanship only.

During the warranty period *audient* will repair at its discretion or replace the faulty unit provided it is returned carriage paid to an authorised *audient* service centre. We will not provide warranty repair if in our opinion the has resulted from unauthorised modification, misuse, negligence or accident.

We accept liability to repair or replace your iD22 as described above. We do not accept any additional liability. This warranty does not affect any legal rights you may have against the person who supplied this product - it is additional to those rights.

Warranty Limitations

This warranty does not cover damage resulting from accident or misuse. The warranty is void unless repairs are carried out by an authorised service centre. The warranty is void if the unit has been modified other than at the manufacturer's instruction. The warranty does not cover components which have a limited life, and which are expected to be periodically replaced for optimal performance. We do not warrant that the unit shall operate in any other way than as described in this manual.

Audient Ltd
Aspect House
Herriard
Hampshire
RG25 2PN
United Kingdom

Tel: 0044 1256 381944

www.audient.com

Service Information

iD22 contains no user-serviceable components, please refer to qualified service personnel for diagnosis and repair. Your warranty will be void if you tamper with the device at component level. If you have any questions with regard to the repair, please contact Audient Ltd.

In the event your iD22 needs to be repaired, it is necessary to contact Audient Ltd prior to shipping, and a [Return Materials Authorization \(RMA\)](#) number will be assigned. This number will serve as a reference for you and helps facilitate and expedite the return process. When the unit is returned please include this RMA number along with a description of the fault inside the packaging box. Audient requires that shipments be pre-paid (for in-warranty repairs we will cover the return shipping).

To request an RMA, access technical support & FAQs, ask for troubleshooting assistance or make an enquiry, please visit: www.audient.com/support

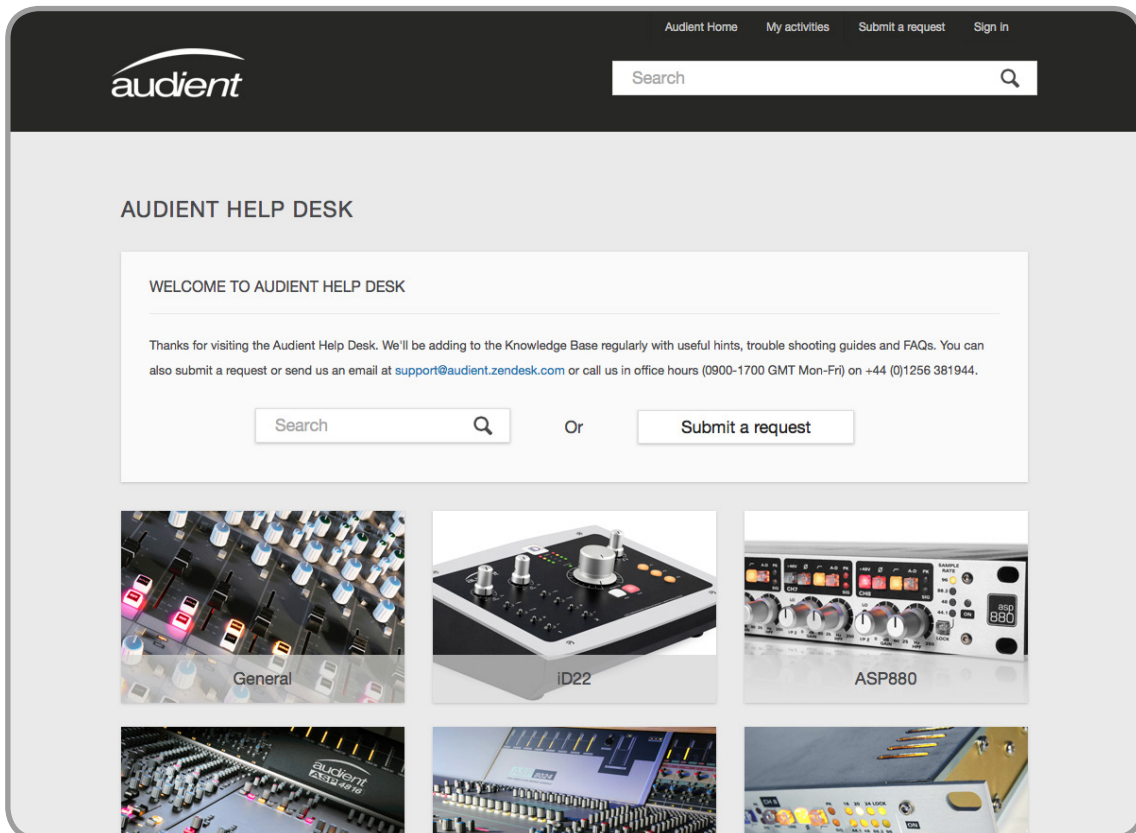

A	Amperes
ADAT	Alesis Digital Audio Tape
ADC	Analogue to Digital Converter
DAW	Digital Audio Workstation
ASP	Analogue Signal Processing
ALT	Alternative
CPU	Central Processing Unit
CUE	Artist Headphone Mix
DAC	Digital to Analogue Converter
dB	Decibel
dBu	Decibel referenced to 0.775Vrms = 0 dBu
dBFS	Decibel Full Scale
DC	Direct Current
D.I	Direct Injection (Instrument Input)
DoC	Declaration of Conformity
DSP	Digital Signal Processing
EQ	Equaliser
FAQ	Frequently Asked Questions
FCC	Federal Communications Commission
GB	Gigabyte
GUI	Graphical User Interface
HPF	High Pass Filter
HV	High Voltage
i/o	Input / Output
JFET	Junction Field Effect Transistor
LED	Light Emitting Diode
RoHS	Restriction of Hazardous Substances
RAM	Random Access Memory
S/PDIF	Sony Philips Digital Interconnect Format
THD+N	Total Harmonic Distortion + Noise
TRS	Tip Ring Sleeve (1/4" Jack Balanced)
TS	Tip Sleeve (1/4" Jack Unbalanced)
USB	Universal Serial Bus
V	Volts
XLR	Extra Live Return, Extremely Low Resistance, Canon X Series, Latching, Resilient Rubber Compound... or make up your own!



USER MANUAL v1.7

August 2014

connect with us.



facebook.com/audient
twitter.com/audientworld
youtube.com/audienthampshire

www.audient.com